

PrimeWall® Drywall Accessories

JUNE 2011



888.474.4876
www.steelnetwork.com

PRODUCT INTRODUCTION

The PrimeWall® Series of drywall framing accessories is for use in non-load-bearing, interior partition applications. Each component is manufactured from mill-certified steel meeting the following requirements:

ASTM A1003/A 1003M Non Structural Grade 33 (230), 33 ksi (230 MPa) minimum yield strength, G40 (Z120) hot-dipped galvanized coating, or equivalent conforming to ASTM C645. Other steel materials with G40 coating are also available upon request.

Because The Steel Network is committed to improving overall quality in the construction industry, we insist on utilizing traceable material for all steel in the manufacturing of the PrimeWall® Series.

It is the goal of The Steel Network to improve the quality of steel framing construction.

PRIMEWALL® PRODUCT NOMENCLATURE

362S125-27

Member Depth:
(Example: 3.625" = 362 x $\frac{1}{8}$ inches)
All member depths are taken in $\frac{1}{8}$ inches.
For all "T" sections, member depth is inside to inside dimension.

Material Thickness:
(Example: 0.027 in. = 27 mils; 1 mil = $\frac{1}{1000}$ in.)
Material thickness is the minimum base metal thickness in mils. Minimum base metal thickness represents 95% of the design thickness.

Flange Width:
(Example: 1 1/8" = 1.25" = 125 x $\frac{1}{8}$ inches)
All flange widths are taken in $\frac{1}{8}$ inches.

Style:
(Example: Stud or Joist section = S)
The four alpha characters utilized by the designator system are:
S = Stud or Joist Sections
T = Track Sections
U = Channel Sections
F = Furring Channel Sections

* EQ20 = Properties of 20gauge material

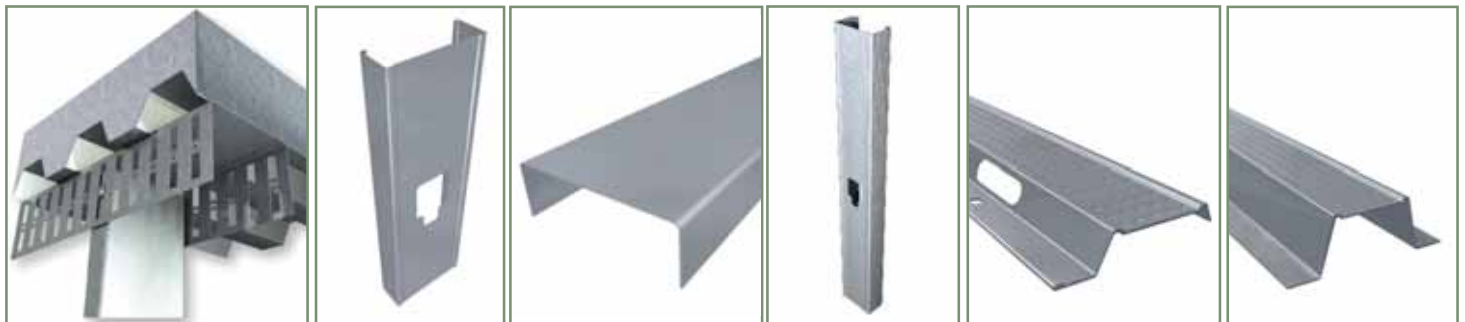
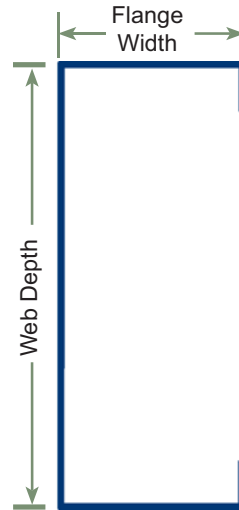

VertiTrack® VT
Slotted Track
p. 2

PrimeWall®
Stud
p. 3

PrimeWall®
Runner Track
p. 6

PrimeWall®
EQ Stud
p.7

PrimeWall®
Resilient Channel
p. 9

PrimeWall®
Furring Channel
p. 10

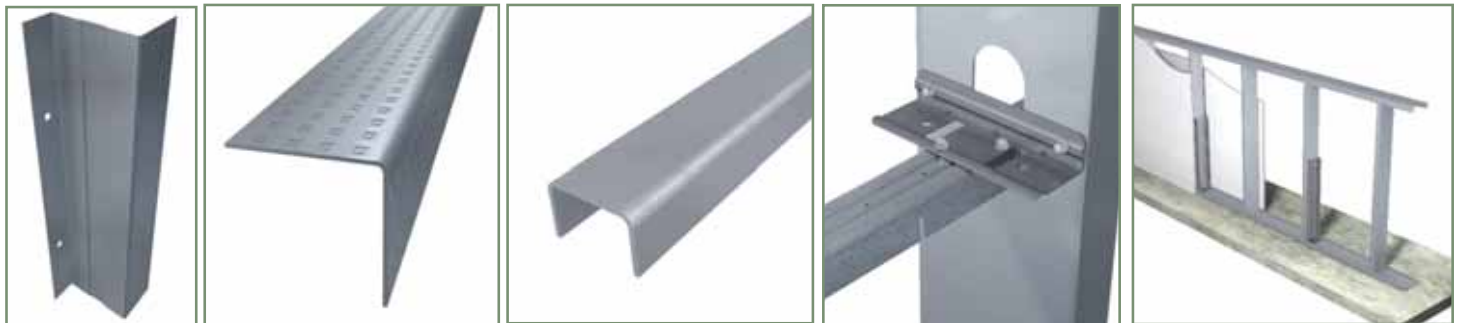

PrimeWall®
Z-Furring Channel
p. 10

PrimeWall®
Angle
p. 11

PrimeWall®
Cold Rolled Channel
p. 12

Wall Bridging Solutions
p. 12

MidWall™
Partial/Half Wall Framing
p. 13-14

Copyright © 2011 The Steel Network Inc. All rights reserved. No part of this publication may be reproduced in whole or in part by any method without the prior written consent of The Steel Network, Inc.

PRODUCT APPLICATION

Introducing VertiTrack®, a slotted deflection track improvement allowing for vertical movement in interior walls. This unique, patent-pending assembly enables a positive attachment between the track and stud flanges to prevent the transfer of forces into the drywall, which could cause damage and violate the fire rated assemblies.

VERTITRACK® VT CONSTRUCTION ADVANTAGES

- ◆ Integral bushing provides for quick and accurate placement without the need to back out screws.
- ◆ Standard #8 Modified Truss-Head screws (minimum 11mm or 0.426" wide screw head) can be fully tightened.
- ◆ Load rated, positive mechanical attachment.
- ◆ Connection allows up to 1 1/2" total vertical deflection.
- ◆ Slots are spaced at 1" centers, allowing for virtually any stud spacing.
- ◆ Staggered guide holes in VertiTrack's web provide for structural attachment using PAF's or screws.
- ◆ Exceeds cycling standards found in ASTM E 1966 and UL2079. Rated for movement types I, II, and III.

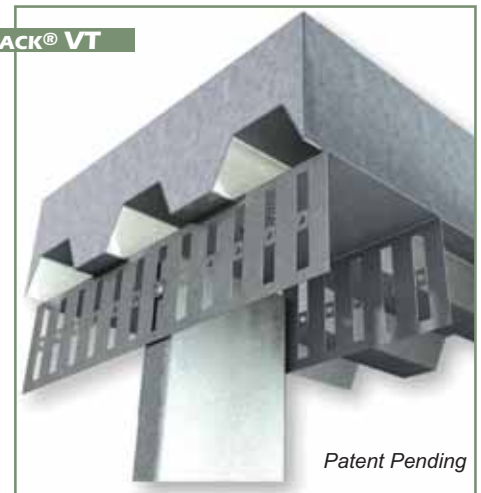

VERTITRACK® VT SECTION PROPERTIES

Section Designation	Design Thickness (in.)	Yield Strength (ksi)	Gross Properties									Torsional Properties					
			Area (in. ²)	Weight (lbs/ft)	I _x (in. ⁴)	S _x (in. ³)	R _x (in.)	I _y (in. ⁴)	S _y (in. ³)	R _y (in.)	J _x ¹⁰⁰⁰ (in. ⁴)	C _w (in. ⁶)	X _o (in.)	R _o (in.)	β	m (in.)	
250VT250-33	0.0346	50	0.259	0.883	0.339	0.256	1.144	0.178	0.107	0.827	0.103	0.212	-1.892	2.36	0.358	1.056	
362VT250-33			0.298	1.015	0.74	0.392	1.575	0.2	0.113	0.82	0.119	0.482	-1.719	2.472	0.516	0.992	
400VT250-33			0.311	1.059	0.914	0.441	1.714	0.207	0.115	0.815	0.124	0.602	-1.67	2.528	0.564	0.973	
600VT250-33			0.38	1.295	2.236	0.728	2.424	0.233	0.121	0.783	0.152	1.52	-1.451	2.932	0.755	0.88	

Section Designation	Design Thickness (in.)	Yield Strength (ksi)	Effective Properties								
			Full Leg								
			I _x (in. ⁴)	S _x (in. ³)	M _x (k-in.)	I _y ¹ (in. ⁴)	S _y ¹ (in. ³)	M _y ¹ (k-in.)	I _y ² (in. ⁴)	S _y ² (in. ³)	M _y ² (k-in.)
250VT250-33	0.0346	50	0.236	0.172	5.16	0.17	0.101	3.024	0.01	0.009	0.065
362VT250-33			0.528	0.272	8.131	0.177	0.102	3.067	0.01	0.009	0.067
400VT250-33			0.658	0.308	9.218	0.178	0.103	3.075	0.01	0.009	0.068
600VT250-33			1.669	0.448	13.421	0.183	0.104	3.104	0.011	0.01	0.071

MATERIAL COMPOSITION

Manufactured from certified ASTM A1003/A1003M Structural Grade 50 (340) Type H, ST50H (ST340H): 50ksi (340MPa) minimum yield strength, 65ksi (450MPa) minimum tensile strength, 33mil minimum thickness (20 gauge, 0.0346" design thickness) with ASTM A653/A653M G60 (Z180) hot dipped galvanized coating.

Section Designation	Design Thickness (in.)	Yield Strength (ksi)	Effective Properties								
			Net (Slotted) Leg								
			I _x (in. ⁴)	S _x (in. ³)	M _x (k-in.)	I _y ¹ (in. ⁴)	S _y ¹ (in. ³)	M _y ¹ (k-in.)	I _y ² (in. ⁴)	S _y ² (in. ³)	M _y ² (k-in.)
250VT250-33	0.0346	50	0.118	0.089	2.915	0.082	0.038	1.144	0.082	0.038	1.144
362VT250-33			0.287	0.152	4.973	0.085	0.038	1.152	0.085	0.038	1.15
400VT250-33			0.366	0.177	5.764	0.086	0.039	1.153	0.086	0.038	1.151
600VT250-33			1.024	0.286	8.56	0.089	0.039	1.159	0.088	0.039	1.153

PRODUCT QUANTITY/ ORDER INFORMATION

Section	Lbs/Ft	Pcs/Skid
250VT250-33	0.883	120
362VT250-33	1.015	160
400VT250-33	1.059	160
600VT250-33	1.295	96

Notes:

- ◆ Section properties and capacities are calculated in accordance with AISI-S100-07 Specification.
- ◆ Tabulated gross properties are based on the full, unreduced cross section of the track away from slots.
- ◆ Effective section properties incorporate the strength increase from cold work of forming as applicable per AISI-S100-07, Sec. A7.2.
- ◆ Net effective section properties are calculated at a cross section through the slot.
- ◆ For deflection calculations, use the effective moment of inertia (I_x). This effective moment of inertia is calculated at a stress 0.6 F_y (service load level).
- ◆ Properties (I_y, S_y and M_y)¹ are based on the web element in compression while (I_y, S_y and M_y)² are based on the web element in tension.

UL CLASSIFIED HEAD OF WALL ASSEMBLIES

HW-D-0043, HW-D-0044, HW-D-0054, HW-D-0088, HW-D-0099, HW-D-0154, HW-D-0184, HW-D-0194, HW-D-0218, HW-D-0252, HW-D-0259, HW-D-0264, HW-D-0324, HW-D-0363, HW-D-0377, HW-D-0388, HW-D-0456, HW-D-0538, HW-D-0539, HW-D-0540, HW-D-0548, HW-D-0606

LIMITING HEIGHTS

VertiTrack® VT	Wall Stud Thickness	Uniform Lateral Load (psf) and Stud Spacing (in)									Allowable Load (lbs)
		5 psf			10 psf			15 psf			
		12" o.c.	16" o.c.	24" o.c.	12" o.c.	16" o.c.	24" o.c.	12" o.c.	16" o.c.	24" o.c.	
XXXVT250-33 (50 ksi)	18 mil-25 ga to 33 mil-20 ga (or EQ Studs)	47' 2"	35' 5"	23' 7"	23' 7"	17' 8"	11' 9"	15' 18"	11' 9"	N/A	118

Notes:

- ◆ Wall heights are based on allowable reaction load at top of the wall.
- ◆ Wall stud size should be determined independently. Wall heights based on stud strength and stiffness should be checked.
- ◆ Allowable loads are based on strength from track leg bending and strength from # 8 screw pullout from stud or pull through the track.
- ◆ VertiTrack® VT has a yield strength equal or greater than 50 ksi.
- ◆ Attach VertiTrack® VT pieces together at splice locations with a piece of stud

PRIMEWALL® STUDS

The PrimeWall® Drywall Studs are used in non-load-bearing wall systems that support gypsum board construction. PrimeWall® Studs are available in 18mil, 27mil, and 30mil (25, 22 and 20 gauge-non-structural) thicknesses, and 1.625", 2.5", 3.5", 3.625", 4", 5.5", and 6" depths. Each PrimeWall® Stud is manufactured from mill-certified steel meeting the following requirements:

ASTM A1003/A 1003M Non Structural Grade 33 (230), 33 ksi (230 MPa) minimum yield strength, G40 (Z120) hot-dipped galvanized coating, or equivalent conforming to ASTM C645. Other steel materials with G40 coating are also available upon request.

PrimeWall® Studs contain knurled flanges for quick fastener placement when connecting sheathing. Pre-punched knockouts are spaced at regular intervals for rapid installation of bridging, electrical wiring, and plumbing.

PRODUCT QUANTITY/ORDER INFORMATION

PrimeWall® Stud Designation	Weight in Lbs. Per Linear Foot			Pcs/Skid
	18mil (25ga)	27mil (22ga)	30mil (20ga)	
162S125	.27	.41	.45	400
250S125	.33	.49	.54	400
350S125	.39	.59	.65	300
362S125	.40	.60	.66	300
400S125	.42	.64	.70	300
550S125	.52	.78	.86	200
600S125	.55	.83	.91	200

- ◆ Knockout is .75" wide in 1.625" and 2.5" studs
- ◆ Knockout is 1.5" wide knockout in 3.5" and wider studs
- ◆ Knockouts begin 12" from the bottom and are spaced vertically every 24" o.c. for East & Central Region studs; for West Region studs, knockouts begin 24" from the bottom and are spaced vertically every 24" o.c.

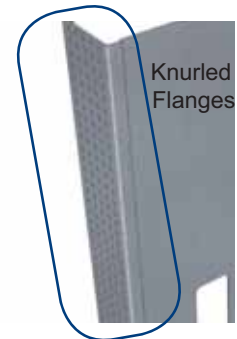

PRIMEWALL® STUDS SECTION PROPERTIES TABLE NOTES

- ◆ The centerline bend radius is the greater of 2 times the design thickness or 3/32".
- ◆ Web depth for track sections is equal to the nominal height plus 2 times the design thickness plus the bend radius.
- ◆ Hems on non-structural track sections are ignored.
- ◆ Effective properties incorporate the strength increase from the cold work of forming as applicable per AISI-NAS, Sec. A7.2.
- ◆ Tabulated gross properties are based on the full un-reduced cross section of the studs, away from punchouts.
- ◆ For deflection calculations, use the effective moment of inertia.

NON-STRUCTURAL (S) STUD SECTION PROPERTIES

Section	Design Thickness (in)	Gross							Effective - 33ksi					Torsional				
		Area (in²)	Weight (lb/ft)	Ixx (in⁴)	Sxx (in³)	Rx (in)	Iyy (in⁴)	Ry (in)	Ixx (in⁴)	Sxx (in³)	Ma (in-k)	Va (lb)	Ycg (in)	Jx1000 (in⁴)	Cw (in⁶)	Xo (in)	Ro (in)	β
162S125-18	0.0188	0.080	0.27	0.038	0.046	0.686	0.016	0.447	0.034	0.033	0.66	309	0.924	0.009	0.009	-1.061	1.340	0.373
162S125-27	0.0283	0.120	0.41	0.056	0.068	0.682	0.023	0.443	0.055	0.051	1.01	526	0.909	0.032	0.013	-1.049	1.327	0.375
162S125-30	0.0312	0.131	0.45	0.061	0.075	0.681	0.026	0.441	0.060	0.059	1.16	579	0.894	0.043	0.014	-1.046	1.323	0.376
250S125-18	0.0188	0.097	0.33	0.099	0.079	1.014	0.019	0.439	0.089	0.059	1.17	247	1.391	0.011	0.023	-0.930	1.444	0.585
250S125-27	0.0283	0.144	0.49	0.147	0.118	1.009	0.027	0.434	0.144	0.092	1.81	700	1.372	0.039	0.033	-0.919	1.432	0.589
250S125-30	0.0312	0.159	0.54	0.161	0.129	1.008	0.030	0.433	0.159	0.104	2.06	851	1.354	0.052	0.036	-0.915	1.429	0.590
350S125-18	0.0188	0.115	0.39	0.215	0.123	1.336	0.021	0.423	0.197	0.087	1.72	172	1.992	0.014	0.049	-0.819	1.648	0.735
350S125-27	0.0283	0.173	0.59	0.320	0.183	1.361	0.030	0.418	0.312	0.147	2.90	589	1.892	0.046	0.071	-0.809	1.637	0.756
350S125-30	0.0312	0.190	0.65	0.351	0.201	1.359	0.033	0.417	0.346	0.167	3.29	790	1.871	0.062	0.077	-0.805	1.634	0.757
362S125-18	0.0188	0.118	0.40	0.234	0.129	1.409	0.021	0.421	0.215	0.090	1.78	166	2.075	0.014	0.053	-0.807	1.677	0.768
362S125-27	0.0283	0.176	0.60	0.347	0.192	1.404	0.031	0.416	0.338	0.154	3.05	568	1.957	0.047	0.077	-0.797	1.667	0.771
362S125-30	0.0312	0.194	0.66	0.381	0.210	1.402	0.033	0.415	0.375	0.175	3.46	761	1.935	0.063	0.084	-0.794	1.664	0.772
400S125-18¹	0.0188	0.125	0.42	0.294	0.147	1.536	0.021	0.414	0.265	0.099	1.96	150	2.325	0.015	0.066	-0.774	1.769	0.809
400S125-27	0.0283	0.187	0.64	0.438	0.219	1.531	0.031	0.410	0.426	0.178	3.52	511	2.150	0.050	0.096	-0.764	1.759	0.811
400S125-30	0.0312	0.206	0.70	0.481	0.240	1.529	0.034	0.408	0.473	0.202	3.99	686	2.127	0.067	0.105	-0.761	1.756	0.812
550S125-18¹	0.0188	0.153	0.52	0.630	0.229	2.029	0.023	0.390						0.018	0.138	-0.666	2.171	0.906
550S125-27	0.0283	0.229	0.78	0.938	0.341	2.023	0.034	0.385	0.925	0.253	5.00	366	3.072	0.061	0.202	-0.657	2.162	0.908
550S125-30	0.0312	0.252	0.86	1.031	0.375	2.021	0.037	0.384	1.017	0.307	6.06	491	2.956	0.082	0.220	-0.654	2.159	0.908
600S125-18¹	0.0188	0.162	0.55	0.778	0.259	2.189	0.024	0.382						0.019	0.169	-0.637	2.312	0.924
600S125-27¹	0.0283	0.243	0.83	1.160	0.387	2.183	0.035	0.377	1.145	0.274	5.42	335	3.413	0.065	0.247	-0.628	2.303	0.926
600S125-30	0.0312	0.268	0.91	1.275	0.425	2.181	0.038	0.376	1.259	0.331	6.54	448	3.292	0.087	0.270	-0.625	2.300	0.926

¹ Web-height to thickness ratio exceeds 200. Web stiffeners are required at all support points and concentrated loads.

PRIMEWALL® STUDS

The PrimeWall® Series of interior non-load-bearing partitions are not designed to carry axial loads. PrimeWall® Stud limiting heights are based on stress or deflection limits for given lateral loads. Height limitations consider each of the following: steel thickness, stud dimensions, stud spacing and the allowable deflection limit.

Important Notes:

1. Composite wall sheathed on both sides, full-height, with 1/2" gypsum wallboard for 18 and 30mil.
2. Sheathing attached with #6 screws min. at 12" o.c. max.
3. 362S125 member is based on 350S125 test data. For both 362S125 and 350S125 members use values listed for 362S125.

PRIMEWALL® STUD PROPERTIES						LATERAL LOAD									
PrimeWall® Stud Designation	Depth (Inches)	Mils	Gauge	Design Thickness		Spacing	5psf			7.5psf			10psf		
				Inches	mm		Deflection Limit			Deflection Limit			Deflection Limit		
				Inches	L/120	L/240	L/360	L/120	L/240	L/360	L/120	L/240	L/360		
162S125-xx	1.625	18	25	0.0188	0.48	12	11' 2"	8' 10"		9' 9"			8' 10"		
						16	10' 7"	8' 4"		8' 10"			8' 4"		
						24	9' 9"	7' 11"		8' 0"					
		30	20	0.0312	0.79	12	12' 5"	9' 11"		10' 10"			9' 11"		
						16	11' 6"	9' 2"		10' 1"			9' 2"		
						24	10' 5"	8' 3"		9' 2"			8' 3"		
250S125-xx	2.5	18	25	0.0188	0.48	12	15' 1"	11' 11"	10' 5"	12' 4" f	10' 5"	9' 1"	10' 9" f	9' 6"	7' 3"
						16	13' 3" f	11' 3"	9' 10"	10' 10" f	9' 10"	8' 7"	9' 5" f	8' 11"	6' 7"
						24	11' 10" f	10' 7"	9' 3"	9' 8" f	9' 3"	8' 1"	8' 5" f	8' 5"	5' 9"
		30	20	0.0312	0.79	12	16' 8"	13' 2"	11' 6"	14' 7"	11' 6"	10' 0"	13' 2"	10' 5"	9' 1"
						16	15' 4"	12' 1"	10' 6"	13' 4"	10' 6"	9' 2"	12' 1"	9' 6"	8' 4"
						24	13' 9"	10' 9"	9' 4"	11' 11"	9' 4"	8' 1"	10' 9"	8' 6"	7' 4"
350S125-xx	3.5	18	25	0.0188	0.48	12	17' 8" f	15' 4"	13' 3"	14' 3" f	13' 3"	11' 7"	12' 5" f	12' 0"	10' 5"
						16	15' 4" f	14' 4"	12' 4"	12' 5" f	12' 5"	10' 10"	10' 9" f	10' 9" f	9' 9"
						24	13' 9" f	13' 5"	11' 7"	11' 0" f	11' 0" f	10' 1"	9' 5" f	9' 5" f	9' 1"
		30	20	0.0312	0.79	12	21' 8"	17' 1"	14' 10"	18' 11"	14' 10"	12' 10"	17' 1"	13' 5"	11' 8"
						16	19' 11"	15' 8"	13' 7"	17' 5"	13' 7"	11' 9"	15' 8"	12' 3"	10' 7"
						24	17' 9"	14' 0"	12' 0"	15' 6"	12' 0"	10' 5"	14' 0"	10' 10"	9' 4"
362S125-xx	3.625	18	25	0.0188	0.48	12	17' 8" f	15' 4"	13' 3"	14' 3" f	13' 3"	11' 7"	12' 5" f	12' 0"	10' 5"
						16	15' 4" f	14' 4"	12' 4"	12' 5" f	12' 5"	10' 10"	10' 9" f	10' 9" f	9' 9"
						24	13' 9" f	13' 5"	11' 7"	11' 0" f	11' 0" f	10' 1"	9' 5" f	9' 5" f	9' 1"
		30	20	0.0312	0.79	12	21' 8"	17' 1"	14' 10"	18' 11"	14' 10"	12' 10"	17' 1"	13' 5"	11' 8"
						16	19' 11"	15' 8"	13' 7"	17' 5"	13' 7"	11' 9"	15' 8"	12' 3"	10' 7"
						24	17' 9"	14' 0"	12' 0"	15' 6"	12' 0"	10' 5"	14' 0"	10' 10"	9' 4"
400S125-xx	4	18	25	0.0188	0.48	12	19' 6" f	16' 5"	14' 4"	15' 9" f	14' 4"	12' 6"	13' 8" f	13' 0"	11' 4"
						16	17' 2" f	15' 4"	13' 4"	13' 10" f	13' 4"	11' 8"	11' 11" f	11' 11" f	10' 6"
						24	15' 1" f	14' 2"	12' 4"	12' 1" f	12' 1" f	10' 9"	10' 5" f	10' 5" f	9' 9"
		30	20	0.0312	0.79	12	24' 0"	19' 0"	16' 6"	20' 11"	16' 6"	14' 4"	19' 0"	14' 11"	12' 11"
						16	22' 0"	17' 6"	15' 2"	19' 3"	15' 2"	13' 1"	17' 6"	13' 8"	11' 10"
						24	19' 8"	15' 7"	13' 5"	17' 1" f	13' 5"	11' 7"	14' 9" f	12' 1"	10' 5"
600S125-xx	6	18	25	0.0188	0.48	12	22' 10"	22' 1"	19' 4"	18' 7" f	18' 7" f	16' 9"	16' 2" f	16' 2" f	15' 0"
						16	19' 9" f	19' 9" f	17' 11"	16' 2" f	16' 2" f	15' 7"	14' 0" f	14' 0" f	13' 10"
						24	16' 9" f	16' 9" f	16' 9" f	13' 5" f	13' 5" f	13' 5" f	11' 5" f	11' 5" f	11' 5" f
		30	20	0.0312	0.79	12	32' 1"	25' 6"	22' 3"	28' 0"	22' 3"	19' 5"	24' 7" f	20' 3"	17' 6"
						16	29' 2"	23' 2"	20' 3"	24' 9" f	20' 3"	17' 8"	21' 5" f	18' 4"	15' 10"
						24	25' 1" f	20' 3"	17' 8"	20' 6" f	17' 8"	15' 5"	17' 9" f	16' 0"	13' 8"

f: Flexural stress controls allowable wall height.

PRIMEWALL® STUDS

The PrimeWall® Series of interior non-load-bearing partitions are not designed to carry axial loads. PrimeWall® Stud limiting heights are based on stress or deflection limits for given lateral loads. Height limitations consider each of the following: steel thickness, stud dimensions, stud spacing and the allowable deflection limit.

Important Notes:

1. Lateral loads multiplied by 0.70 for deflection determination per IBC, Sec. 1604.3 and AISI Wall Stud Standard, Sec. B1.
2. Check end reactions for web crippling.
3. Limiting heights based on continuous support of each flange over the full length of the stud.
4. Heights based on steel properties only.
5. For 350S125 members use values for 362S125.
6. Calculations for 362S125 are based on 350S125 properties.

PRIMEWALL® STUD - NON-COMPOSITE						LATERAL LOAD									
PrimeWall® Stud Designation	Depth (Inches)	Mils	Gauge	Design Thickness		Spacing	5psf			7.5psf			10psf		
				Inches	mm		Deflection Limit			Deflection Limit			Deflection Limit		
				Inches	mm	L/120	L/240	L/360	L/120	L/240	L/360	L/120	L/240	L/360	
162S125-xx	1.625	18	25	0.0188	0.48	12	9' 0"	8' 7"	7' 6"	7' 4"	7' 4"	6' 7"	6' 4"	6' 4"	6' 0"
						16	7' 9"	7' 9"	6' 10"	6' 4"	6' 4"	6' 0"	5' 6"	5' 6"	5' 5"
						24	6' 4"	6' 4"	6' 0"	5' 2"	5' 2"	5' 2"	4' 6"	4' 6"	4' 6"
		27	22	0.0283	0.72	12	11' 10"	10' 1"	8' 10"	9' 8"	8' 10"	7' 8"	8' 4"	8' 0"	7' 0"
						16	10' 3"	9' 2"	8' 0"	8' 4"	8' 0"	7' 0"	7' 3"	7' 3"	6' 4"
						24	8' 4"	8' 0"	7' 0"	6' 10"	6' 10"	6' 1"	5' 11"	5' 11"	5' 7"
		30	20	0.0312	0.79	12	12' 7"	10' 5"	9' 1"	10' 3"	9' 1"	7' 11"	8' 11"	8' 3"	7' 3"
						16	10' 11"	9' 5"	8' 3"	8' 11"	8' 3"	7' 3"	7' 9"	7' 6"	6' 7"
						24	8' 11"	8' 3"	7' 3"	7' 3"	7' 3"	6' 4"	6' 4"	6' 4"	5' 9"
250S125-xx	2.5	18	25	0.0188	0.48	12	12' 6"	11' 10"	10' 4"	10' 3"	10' 3"	9' 1"	8' 10"	8' 10"	8' 3"
						16	10' 10"	10' 9"	9' 5"	8' 10"	8' 10"	8' 3"	7' 8"	7' 8"	7' 6"
						24	8' 10"	8' 10"	8' 3"	7' 3"	7' 3"	7' 2"	6' 3"	6' 3"	6' 3"
		27	22	0.0283	0.72	12	16' 0"	13' 11"	12' 2"	13' 1"	12' 2"	10' 8"	11' 4"	11' 1"	9' 8"
						16	13' 10"	12' 8"	11' 1"	11' 4"	11' 1"	9' 8"	9' 10"	9' 10"	8' 9"
						24	11' 4"	11' 1"	9' 8"	9' 3"	9' 3"	8' 5"	8' 0"	8' 0"	7' 8"
		30	20	0.0312	0.79	12	17' 0"	14' 5"	12' 7"	13' 11"	12' 7"	11' 0"	12' 0"	11' 5"	10' 0"
						16	14' 9"	13' 1"	11' 5"	12' 0"	11' 5"	10' 0"	10' 5"	10' 4"	9' 1"
						24	12' 0"	11' 5"	10' 0"	9' 10"	9' 10"	8' 9"	8' 6"	8' 6"	7' 11"
362S125-xx	3.625	18	25	0.0188	0.48	12	14' 0"	14' 0"	14' 0"	11' 6"	11' 6"	11' 6"	9' 11"	9' 11"	9' 11"
						16	12' 2"	12' 2"	12' 2"	9' 11"	9' 11"	9' 11"	8' 7"	8' 7"	8' 7"
						24	9' 11"	9' 11"	9' 11"	8' 1"	8' 1"	8' 1"	7' 0"	7' 0"	7' 0"
		27	22	0.0283	0.72	12	18' 10"	18' 7"	16' 3"	15' 5"	15' 5"	14' 2"	13' 4"	13' 4"	12' 11"
						16	16' 4"	16' 4"	14' 9"	13' 4"	13' 4"	12' 11"	11' 7"	11' 7"	11' 7"
						24	13' 4"	13' 4"	12' 11"	10' 11"	10' 11"	10' 11"	9' 5"	9' 5"	9' 5"
		30	20	0.0312	0.79	12	20' 3"	19' 2"	16' 9"	16' 7"	16' 7"	14' 7"	14' 4"	14' 4"	13' 3"
						16	17' 7"	17' 5"	15' 3"	14' 4"	14' 4"	13' 3"	12' 5"	12' 5"	12' 1"
						24	14' 4"	14' 4"	13' 3"	11' 8"	11' 8"	11' 7"	10' 2"	10' 2"	10' 2"
400S125-xx	4	18	25	0.0188	0.48	12	14' 9"	14' 9"	14' 9"	12' 1"	12' 1"	12' 1"	10' 5"	10' 5"	10' 5"
						16	12' 10"	12' 10"	12' 10"	10' 5"	10' 5"	10' 5"	9' 1"	9' 1"	9' 1"
						24	10' 5"	10' 5"	10' 5"	8' 6"	8' 6"	8' 6"	7' 5"	7' 5"	7' 5"
		27	22	0.0283	0.72	12	19' 11"	19' 11"	17' 6"	16' 3"	16' 3"	15' 4"	14' 1"	14' 1"	13' 11"
						16	17' 3"	17' 3"	15' 11"	14' 1"	14' 1"	13' 11"	12' 2"	12' 2"	12' 2"
						24	14' 1"	14' 1"	13' 11"	11' 6"	11' 6"	11' 6"	9' 11"	9' 11"	9' 11"
		30	20	0.0312	0.79	12	21' 5"	20' 8"	18' 1"	17' 6"	17' 6"	15' 10"	15' 2"	15' 2"	14' 4"
						16	18' 6"	18' 6"	16' 5"	15' 2"	15' 2"	14' 4"	13' 1"	13' 1"	13' 1"
						24	15' 2"	15' 2"	14' 4"	12' 4"	12' 4"	12' 4"	10' 8"	10' 8"	10' 8"
600S125-xx	6	27	22	0.0283	0.72	12	26' 8"	26' 8"	23' 11"	21' 10"	21' 10"	20' 11"	18' 11"	18' 11"	18' 11"
						16	23' 2"	23' 2"	21' 9"	18' 11"	18' 11"	18' 11"	16' 4"	16' 4"	16' 4"
						24	18' 11"	18' 11"	18' 11"	15' 5"	15' 5"	15' 5"	13' 4"	13' 4"	13' 4"
		30	20	0.0312	0.79	12	28' 10"	28' 4"	24' 9"	23' 6"	23' 6"	21' 8"	20' 4"	20' 4"	19' 8"
						16	24' 11"	24' 11"	22' 6"	20' 4"	20' 4"	19' 8"	17' 8"	17' 8"	17' 8"
24	20' 4"	20' 4"	19' 8"	16' 8"	16' 8"	16' 8"	14' 5"	14' 5"	14' 5"						

PRODUCT APPLICATION

The PrimeWall® Series Track is manufactured from corrosion-resistant, galvanized steel and is available in a wide variety of configurations. By designing the inside width of the track to accommodate the outside width of the studs, PrimeWall Series Track can readily address all construction situations.

MATERIAL COMPOSITION

ASTM A1003/A 1003M Non Structural Grade 33 (230), 33 ksi (230 MPa) minimum yield strength, G40 (Z120) hot-dipped galvanized coating, or equivalent conforming to ASTM C645. Other steel materials with G40 coating are also available upon request.

PRODUCT NOMENCLATURE

Refer to the page 1 of this catalog for PrimeWall Track nomenclature. Refer to the page 3 of this catalog for section properties table notes.



PRIMEWALL® SERIES TRACK SECTION PROPERTIES

Section	Design Thickness	Gross								Effective - 33ksi					Torsional				
		Area	Weight	Ixx	Sxx	Rx	Iyy	Ry	Ixx	Sxx	Ma	Va	Ycg	J ^{x1000}	Cw	Xo	Ro	β	
		(in²)	(lb/ft)	(in⁴)	(in³)	(in)	(in⁴)	(in)	(in⁴)	(in³)	(in-k)	(lb)	(in)	(in⁴)	(in⁶)	(in)	(in)		
162T125-18	0.0188	0.078	0.26	0.042	0.048	0.740	0.013	0.411	0.031	0.026	0.51	309	1.093	0.009	0.007	-0.893	1.230	0.473	
162T125-27	0.0283	0.117	0.40	0.063	0.072	0.735	0.020	0.410	0.050	0.044	0.87	577	1.048	0.031	0.010	-0.886	1.221	0.474	
162T125-30	0.0312	0.129	0.44	0.070	0.079	0.735	0.022	0.409	0.057	0.050	1.00	637	1.038	0.042	0.012	-0.884	1.220	0.475	
250T125-18	0.0188	0.094	0.32	0.105	0.080	1.057	0.015	0.399	0.079	0.046	0.90	237	1.593	0.011	0.018	-0.781	1.373	0.677	
250T125-27	0.0283	0.141	0.48	0.157	0.119	1.053	0.022	0.398	0.129	0.079	1.56	700	1.519	0.038	0.027	-0.774	1.366	0.679	
250T125-30	0.0312	0.156	0.53	0.173	0.131	1.053	0.025	0.397	0.145	0.090	1.77	851	1.507	0.051	0.030	-0.773	1.365	0.679	
350T125-18	0.0188	0.113	0.38	0.221	0.122	1.400	0.016	0.382	0.176	0.063	1.25	167	2.278	0.013	0.039	-0.685	1.605	0.818	
350T125-27	0.0283	0.170	0.58	0.331	0.182	1.396	0.025	0.381	0.277	0.128	2.53	566	2.044	0.045	0.057	-0.680	1.599	0.819	
350T125-30	0.0312	0.187	0.64	0.365	0.200	1.396	0.027	0.380	0.312	0.145	2.86	758	2.030	0.061	0.063	-0.679	1.598	0.820	
362T125-18	0.0188	0.115	0.39	0.240	0.127	1.442	0.017	0.380	0.192	0.066	1.30	161	2.366	0.014	0.042	-0.675	1.637	0.830	
362T125-27	0.0283	0.173	0.59	0.358	0.191	1.438	0.025	0.378	0.301	0.135	2.66	546	2.109	0.046	0.062	-0.670	1.631	0.831	
362T125-30	0.0312	0.191	0.65	0.395	0.210	1.438	0.027	0.378	0.339	0.152	3.01	731	2.095	0.062	0.068	-0.669	1.630	0.832	
400T125-18¹	0.0188	0.122	0.42	0.300	0.145	1.566	0.017	0.373	0.243	0.072	1.43	146	2.634	0.014	0.052	-0.647	1.735	0.861	
400T125-27	0.0283	0.184	0.63	0.449	0.217	1.562	0.025	0.372	0.380	0.156	3.08	494	2.306	0.049	0.077	-0.641	1.729	0.862	
400T125-30	0.0312	0.203	0.69	0.495	0.239	1.562	0.028	0.371	0.427	0.176	3.49	661	2.289	0.066	0.085	-0.640	1.729	0.863	
550T125-27	0.0283	0.226	0.77	0.948	0.336	2.046	0.027	0.348	0.836	0.207	4.09	357	3.337	0.060	0.160	-0.550	2.150	0.935	
550T125-30	0.0312	0.250	0.85	1.045	0.370	2.046	0.030	0.347	0.931	0.252	4.97	478	3.223	0.081	0.176	-0.549	2.147	0.935	
600T125-27¹	0.0283	0.241	0.82	1.168	0.381	2.204	0.028	0.340	1.041	0.225	4.44	327	3.693	0.064	0.195	-0.525	2.291	0.948	
600T125-30	0.0312	0.265	0.90	1.288	0.419	2.204	0.031	0.340	1.159	0.272	5.37	438	3.573	0.086	0.214	-0.524	2.291	0.948	

¹ Web-height to thickness ratio exceeds 200. Web stiffeners are required at all support points and concentrated loads.

PRODUCT QUANTITY/ORDER INFORMATION

PrimeWall® Track Designation	Weight in Lbs. Per Linear Foot			Pcs/Skid
	18mil (25ga)	27mil (22ga)	30mil (20ga)	
162T125	.26	.40	.44	400
250T125	.32	.48	.53	400
350T125	.38	.58	.64	300
362T125	.39	.59	.65	300
400T125	.42	.63	.69	300
550T125	N/A	.77	.85	200
600T125	N/A	.82	.90	200

Standard Track Length = 10'



PRODUCT APPLICATION

The PrimeWall® EQ Studs are used in non-load-bearing wall systems that support gypsum board construction. PrimeWall® EQ Studs replace 20 gauge non-structural drywall studs in most applications, allowing you to use less material. Each PrimeWall® EQ Stud is manufactured from mill-certified steel meeting material composition requirements listed below.

PrimeWall® EQ Studs contain knurled flanges for fast fastener placement when attaching wallboard. Pre-punched knockouts are spaced at regular intervals for rapid installation of bridging, electrical wiring, and plumbing.

PRIMEWALL® EQ STUDS CONSTRUCTION ADVANTAGES

- ◆ Knurled flanges with no grooves or ribs to interfere with screw placement
- ◆ Wide flanges for increased target area for screws to hit
- ◆ Material is lessened with decreased mil thickness
- ◆ Strengthened with increased yield and deeper lip

PRIMEWALL® EQ STUDS SECTION PROPERTIES TABLE NOTES

1. Section properties are calculated in accordance with AISI NASPEC 2001 with 2004 supplement.
2. Tabulated gross properties are based on the full, unreduced cross section of the stud away from punchouts.
3. Effective section properties don't incorporate strength increase from cold work of forming.
4. Effective moment of inertia I_x is calculated at a stress = 0.6 F_y.



PrimeWall® EQ Stud (19 mil) Physical and Structural Properties

Section	Design Thickness (in.)	Min. Thickness (in.)	Gross Properties							Effective Properties at 50 ksi				Torsional Properties					
			Area	Weight	I _x	S _x	R _x	I _y	R _y	I _x	S _x	M _a	V _a	J _{x1000}	C _w	X _o	R _o	Beta	m
			(in. ²)	(lbs/ft)	(in. ⁴)	(in. ³)	(in.)	(in. ⁴)	(in.)	(in. ⁴)	(in. ³)	(lbs. in.)	(lbs)	(in. ⁴)	(in. ⁶)	(in.)	(in.)		(in.)
162PWS-20EQ	0.0200	0.0190	0.098	0.332	0.045	0.055	0.677	0.026	0.517	0.041	0.041	1241	421	0.013	0.021	-1.296	1.551	0.302	0.744
250PWS-20EQ	0.0200	0.0190	0.115	0.392	0.119	0.095	1.017	0.031	0.515	0.111	0.077	2311	311	0.015	0.045	-1.151	1.620	0.495	0.684
362PWS-20EQ	0.0200	0.0190	0.138	0.468	0.280	0.155	1.427	0.035	0.502	0.262	0.103	3082	208	0.018	0.094	-1.010	1.819	0.692	0.622
400PWS-20EQ	0.0200	0.0190	0.145	0.494	0.353	0.176	1.559	0.036	0.497	0.323	0.115	3432	188	0.019	0.116	-0.971	1.903	0.739	0.603
600PWS-20EQ*	0.0200	0.0190	0.185	0.630	0.924	0.308	2.234	0.040	0.465	0.763	0.186	5576	123	0.025	0.283	-0.810	2.422	0.888	0.524

* Web height-to-thickness ratio exceeds 260. Web stiffeners are required at all bearing end and intermediate locations.

PRODUCT QUANTITY/ORDER INFORMATION

Section	Lbs/Ft	Pcs/Skid
162PWS-20EQ	0.332	400
250PWS-20EQ	0.392	400
362PWS-20EQ	0.468	300
400PWS-20EQ	0.494	300
600PWS-20EQ	0.630	200

- PrimeWall® EQ Studs meet the requirements of Section 5.1 of ASTM C645 for strength.
- PrimeWall® EQ Studs comply with Screw Penetration requirements in paragraph 9.1 and Section 10 of ASTM C645.

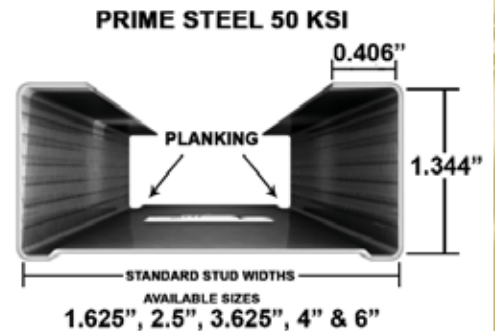

SCREW DESIGN

PrimeWall® EQ Stud (19 mil) Allowable Screw Design Values

Stud Member	Design Thickness (in.)	Min. Thickness (in.)	Yield		Tensile		#6 Screw (0.138" dia.)		#8 Screw (0.164" dia.)		#10 Screw (0.190" dia.)	
			F _y	F _u	Shear	Pullout	Shear	Pullout	Shear	Pullout		
			(ksi)	(ksi)	(lbs)	(lbs)	(lbs)	(lbs)	(lbs)	(lbs)		
PWS-20EQ	0.0200	0.0190	50	65	96	51	104	60	112	70		

MATERIAL COMPOSITION

PrimeWall® EQ studs are made of cold-formed steel coils conforming to ASTM A 1003/A 1003M Structural Steel Grade 50 (340), with 50ksi (340MPa) minimum yield strength and 65ksi (450MPa) minimum tensile strength. Coating is G40 (Z120) hot-dipped galvanized, or equivalent conforming to ASTM C 645. Steel material with G60 and G90 coating are available upon request.

SCREW PENETRATION

PrimeWall® EQ Stud (19 mil) Screw Penetration Test (ASTM C645-09a, ASTM C1002)

Stud Member	Sheathing	Screw	Drill Speed (RPM)	ASTM C 645 Section 10*
PWS-20EQ	Gypsum Board 5/8" Type X	#6 x 1 1/4" Type S Sharp Point	4000	Pass

* Studs must be capable of pulling the head of the screw below surface of gypsum board in less than 2 sec. without spin out.

PRODUCT APPLICATION

PrimeWall® EQ Track is used with PrimeWall EQ Studs in non-load-bearing wall systems that support gypsum board construction. Like PrimeWall EQ Studs, EQ Track allows you to replace 20 gauge non-structural drywall track in most applications. Each PrimeWall EQ Track is manufactured from mill-certified steel meeting material composition requirements listed below.

PRIMEWALL® EQ TRACK CONSTRUCTION ADVANTAGES

- ◆ Designed and engineered to meet standard 20 gauge applications
- ◆ Strengthened with increased yield

PRIMEWALL® EQ TRACK SECTION PROPERTIES TABLE NOTES

1. Section properties are calculated in accordance with AISI NASPEC 2001 with 2004 supplement.
2. Tabulated gross properties are based on the full, unreduced cross section of the track.
3. Effective section properties don't incorporate strength increase from cold work of forming.
4. Effective moment of inertia I_x is calculated at a stress = 0.6 F_y.



PrimeWall® EQ Track (19 mil) Physical and Structural Properties

Section	De-sign Thick-ness (in.)	Min. Thick-ness (in.)	Gross Properties							Effective Properties at 50 ksi				Torsional Properties					
			Area	Weight	I _x	S _x	R _x	I _y	R _y	I _x	S _x	M _a	V _a	J _x 1000	C _w	X _o	R _o	Beta	m
			(in. ²)	(lbs/ft)	(in. ⁴)	(in. ³)	(in.)	(in. ⁴)	(in.)	(in. ⁴)	(in. ³)	(lbs. in.)	(lbs)	(in. ⁴)	(in. ⁶)	(in.)	(in.)		
162PWT125-20EQ	0.02	0.019	0.083	0.281	0.044	0.051	0.734	0.014	0.411	0.030	0.026	766	421	0.011	0.007	-0.887	1.222	0.473	0.503
162PWT200-20EQ	0.02	0.019	0.113	0.383	0.067	0.076	0.771	0.049	0.662	0.036	0.026	775	421	0.015	0.026	-1.586	1.883	0.291	0.869
162PWT250-20EQ	0.02	0.019	0.133	0.451	0.082	0.094	0.786	0.090	0.823	0.038	0.026	767	421	0.018	0.049	-2.065	2.358	0.233	1.116
250PWT125-20EQ	0.02	0.019	0.100	0.341	0.111	0.084	1.052	0.016	0.399	0.079	0.041	1240	295	0.013	0.018	-0.777	1.367	0.677	0.459
250PWT200-20EQ	0.02	0.019	0.130	0.443	0.162	0.123	1.115	0.057	0.661	0.089	0.041	1224	295	0.017	0.066	-1.438	1.936	0.448	0.817
250PWT250-20EQ	0.02	0.019	0.150	0.511	0.195	0.149	1.141	0.103	0.830	0.093	0.041	1218	295	0.020	0.123	-1.900	2.366	0.356	1.060
362PWT125-20EQ	0.02	0.019	0.123	0.417	0.253	0.135	1.437	0.018	0.380	0.172	0.060	1796	201	0.016	0.043	-0.672	1.632	0.830	0.413
362PWT200-20EQ	0.02	0.019	0.153	0.519	0.357	0.191	1.531	0.064	0.647	0.190	0.060	1801	201	0.020	0.153	-1.288	2.103	0.625	0.758
362PWT250-20EQ	0.02	0.019	0.173	0.587	0.427	0.228	1.573	0.117	0.822	0.199	0.060	1800	201	0.023	0.280	-1.727	2.476	0.514	0.996
400PWT125-20EQ	0.02	0.019	0.130	0.443	0.317	0.154	1.562	0.018	0.373	0.210	0.066	1982	182	0.017	0.054	-0.644	1.730	0.861	0.400
400PWT200-20EQ	0.02	0.019	0.160	0.545	0.443	0.215	1.664	0.066	0.641	0.233	0.067	1994	182	0.021	0.191	-1.246	2.176	0.672	0.740
400PWT250-20EQ	0.02	0.019	0.180	0.613	0.528	0.256	1.712	0.120	0.818	0.244	0.067	1995	182	0.024	0.349	-1.677	2.532	0.561	0.977
600PWT125-20EQ	0.02	0.019	0.170	0.579	0.826	0.270	2.204	0.020	0.342	0.486	0.098	2947	120	0.023	0.137	-0.527	2.291	0.947	0.341
600PWT200-20EQ	0.02	0.019	0.200	0.681	1.105	0.361	2.350	0.074	0.607	0.539	0.101	3023	120	0.027	0.485	-1.063	2.650	0.839	0.658
600PWT250-20EQ	0.02	0.019	0.220	0.749	1.292	0.422	2.423	0.136	0.786	0.563	0.101	3034	120	0.029	0.883	-1.457	2.934	0.753	0.884

PRODUCT QUANTITY/ORDER INFORMATION

Section	Lbs/Ft	Pcs/Skid
162PWT-20EQ	0.332	400
250PWT-20EQ	0.392	400
362PWT-20EQ	0.468	300
400PWT-20EQ	0.494	300
600PWT-20EQ	0.630	200

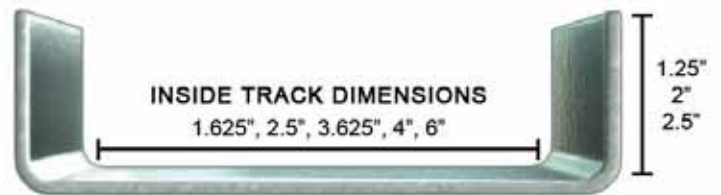

MATERIAL COMPOSITION

PrimeWall® EQ Track is made of cold-formed steel coils conforming to ASTM A 1003/A 1003M Structural Steel Grade 50 (340), with 50ksi (340MPa) minimum yield strength and 65ksi (450MPa) minimum tensile strength. Coating is G40 (Z120) hot-dipped galvanized, or equivalent conforming to ASTM C 645. Steel material with G60 and G90 coating are available upon request.

- PrimeWall® EQ Studs & Track meet the requirements of Section 5.1 of ASTM C645 for strength.

PRODUCT APPLICATION

PrimeWall® Resilient Channel is a highly effective, efficient, low cost product designed to greatly assist in the marked reduction of sound through partitions and ceiling assemblies. To achieve this damping of sound waves, gypsum wallboard is suspended ½” from the stud or joist member. Additional sound mitigation can also be achieved through the use of sound attenuation blankets within the wall or ceiling cavity. Sound absorption can be maximized by utilizing sound attenuation blankets within the wall or floor cavity. PrimeWall® Resilient Channel is manufactured from 25- and 20-gauge corrosion-resistant galvanized steel and is available with single or double legs. Each PrimeWall® Resilient Channel has a 1.25” screw flange and is commonly used in wall applications. Double Leg PrimeWall® Resilient Channel has two legs for rapid installation, and is typically used for ceiling applications with multiple layers of gypsum board. While Double Leg PrimeWall® Resilient Channel is easier to install, it results in a lower STC rating.

MATERIAL COMPOSITION

ASTM A1003/A 1003M Non Structural Grade 33 (230), 33 ksi (230 MPa) minimum yield strength, G40 (Z120) hot-dipped galvanized coating, or equivalent conforming to ASTM C645.

PRODUCT NOMENCLATURE

PrimeWall® Resilient Channel is available in four leg configurations: Single Leg (Hemmed Leg), Single Leg (Un-hemmed Leg), Double Leg (Hemmed Leg), and Double Leg (Un-hemmed Leg), and two overall thicknesses (18mil and 30mil). The hemmed (H) leg tracks are available in 18mil (25ga), and the un-hemmed (NH) leg tracks are available in 30mil (20ga) thickness.

Designate Single Leg as RC1 and Double Leg as RC2, followed by the leg type and thickness.

Example: Single Leg (Hemmed) = **RC1-H-18**

PRODUCT QUANTITY/ORDER INFORMATION

Designation	Size	Thickness	Lbs./Linear Ft.	Pcs/Skid	Length (ft.)
Single Leg PrimeWall® Resilient Channel					
RC1-H-18	.5" x 2"	18mil (25ga)	.170	500	12
RC1-NH-30	.5" x 2.5625"	30mil (20ga)	.270	500	12
Double Leg PrimeWall® Resilient Channel					
RC2-H-18	.5" x 2"	18mil (25ga)	.228	500	12
RC2-NH-30	.5" x 2.5625"	30mil (20ga)	.351	500	12



Single Leg PrimeWall® Resilient Channel (Hemmed Leg-25ga)



Single Leg PrimeWall® Resilient Channel (Un-hemmed Leg-20ga)



Double Leg PrimeWall® Resilient Channel (Hemmed Leg-25ga)



Double Leg PrimeWall® Resilient Channel (Unhemmed Leg-20ga)

PRODUCT APPLICATION

PrimeWall® Furring Channel is a hat-shaped corrosion-resistant framing component used in conjunction with the furring out of masonry walls and ceiling assemblies. PrimeWall® Furring Channel is designed with knurled webs to facilitate faster attachments. For wall applications, furring channels form the support structure needed to secure the interior gypsum board, lathe or veneers to the exterior concrete wall. For ceiling applications, they can provide the horizontal bridge support needed between the building's structure and the designed ceiling (suspended or otherwise).

PrimeWall® Z-Furring Channel is used in conjunction with the furring out of interior masonry or poured concrete wall substrates, in the support of rigid insulation while providing a level plane for sheathing attachment. PrimeWall® Z-Furring Channel should be installed vertically with the 3/4" flange against the substrate. The type of fastener and spacing will vary based on application. Gypsum wallboard may be installed parallel or perpendicular to the Z-furring. Metal lath should be installed perpendicular to the Z-furring.

MATERIAL COMPOSITION

ASTM A1003/A 1003M Non Structural Grade 33 (230), 33 ksi (230 MPa) minimum yield strength, G40 (Z120) hot-dipped galvanized coating, or equivalent conforming to ASTM C645. Other steel materials with G40 coating are also available upon request.

PRODUCT QUANTITY/ORDER INFORMATION

PrimeWall® Hat Furring Channel					
Designation	Size	Thickness	Lbs./Linear Ft.	Pcs/Skid	Length (ft.)
087F125-18*	.875" x 2.625"	18mil (25ga)	.307	500	10
087F125-30	.875" x 2.625"	30mil (20ga)	.484	500	10
087F125-43	.875" x 2.625"	43mil (18ga)	.700	500	10
150F125-18*	1.5" x 2.625"	18mil (25ga)	.377	500	10
150F125-30	1.5" x 2.625"	30mil (20ga)	.600	500	10
150F125-43	1.5" x 2.625"	43mil (18ga)	.866	500	10
PrimeWall® Z-Furring Channel					
Designation	Size	Thickness	Lbs./Linear Ft.	Pcs/Skid	Length (ft.)
100ZF125-18	1"	18mil (25ga)	.195	500	10, 12
100ZF125-30	1"	30mil (20ga)	.324	500	10, 12
150ZF125-18	1.5"	18mil (25ga)	.212	500	10, 12
150ZF125-30	1.5"	30mil (20ga)	.352	500	10, 12
200ZF125-18	2"	18mil (25ga)	.260	500	10, 12
200ZF125-30	2"	30mil (20ga)	.432	500	10, 12

* Hemmed legs available in 18mil (25ga) thickness.

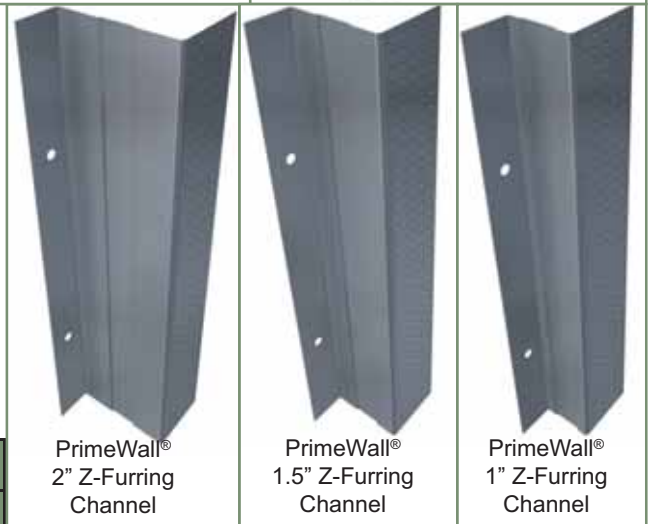
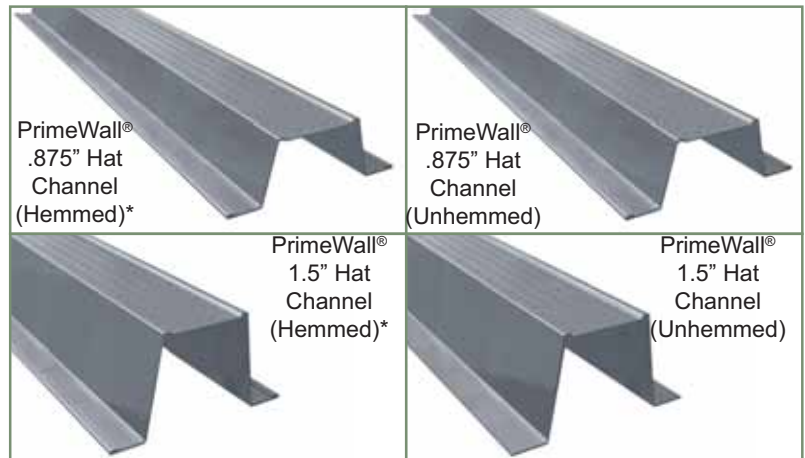

PRODUCT NOMENCLATURE

PrimeWall® Channels are designated as web depth followed by channel type, then flange width and thickness:

Web Depth (decimal(in) x 100) + F or ZF (Channel) + flange width (decimal(in) x 100) + mils

Example: 1.5" web, 1.25" flange, 20ga

Designate: **150F125-30**

PrimeWall® Hat Furring Channels are available in .87" and 1.5" web depths, 1.25" flange width, and 18mils (25ga), 30mils (20ga), and 43mils (18ga) thickness.

PrimeWall® Z-Furring Channels are available in 1", 1.5" and 2" web depths, 1.25" flange width, and 18mils (25ga) and 30mils (20ga) thickness.

PRODUCT APPLICATION

For 1½" and larger ceiling assemblies it is necessary to first suspend U-Channel from the overhead structure with hanger wire. Installation of the drywall can then be accomplished via screw attachment to PrimeWall® Furring Channel that has been secured to the previously installed U-Channel by either clips or wire-ties. Assemblies are installed according to project specification. PrimeWall® Furring Channel is also designed to be attached directly perpendicular to the underside of bar joists by wire-ties (required for fire-rated and multilayer assemblies) spaced at the appropriate intervals.

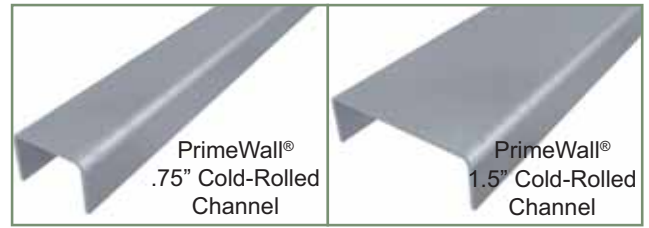

PrimeWall® Cold-Rolled Channel					
Designation	Size	Thick-ness	Lbs./Linear Ft.	Pcs/Skid	Length (ft.)
075U50-54	.5" x .75"	54mil (16ga)	.343	500	10', 16', 20'
150U50-54	.5" x 1.5"	54mil (16ga)	.489	500	10', 16', 20'

PRODUCT NOMENCLATURE

PrimeWall® Cold-Rolled Channel is designated as width followed by channel type and thickness:

Example: 1.5" channel, .5" return lip, 54mils

Designate: **150U50-54**

PRODUCT APPLICATION

PrimeWall® Angle is a multi-purpose 90° knurled angle used in a variety of framing applications, including soffits, floor and ceiling runners, wall bridging, lapped framing conditions, chase walls and laminated gypsum drywall partitions. PrimeWall® Angle is manufactured from mill-certified, galvanized steel. Available widths are 1.5" x 1.5", 2" x 2", and 3" x 3", with thicknesses of 18mils (25ga), 30mils (20ga), 43mils (18ga) and 54mils (16ga).

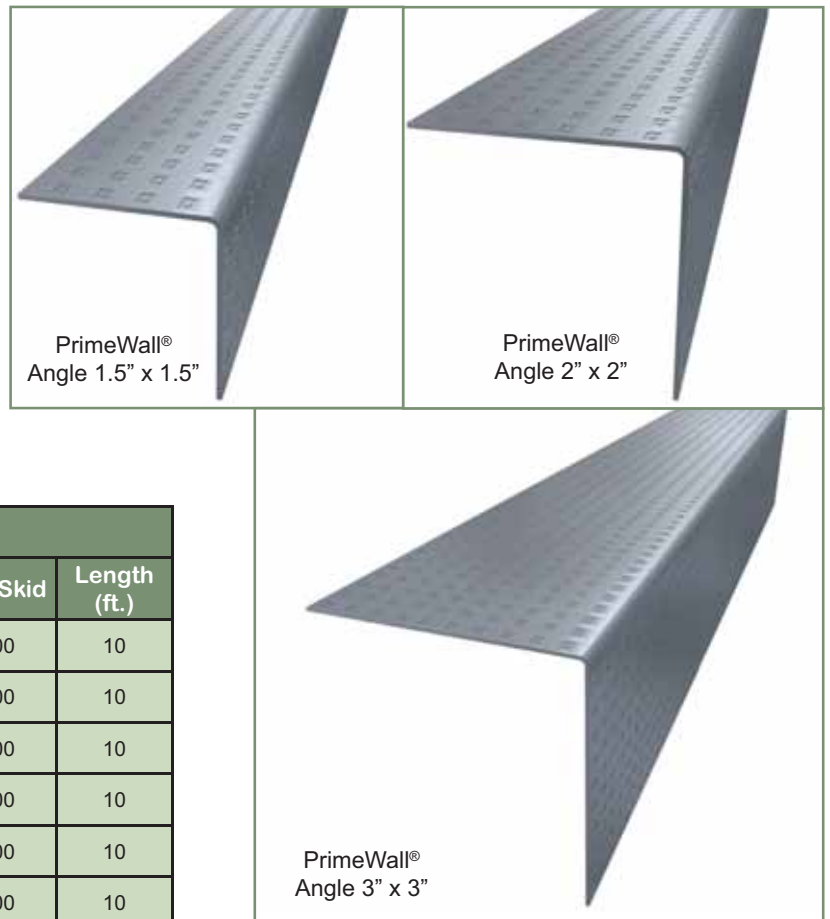

MATERIAL COMPOSITION

ASTM A1003/A 1003M Non Structural Grade 33 (230), 33 ksi (230 MPa) minimum yield strength, G40 (Z120) hot-dipped galvanized coating, or equivalent conforming to ASTM C645. Other steel materials with G40 coating are also available upon request.

PRODUCT QUANTITY/ORDER INFORMATION

PrimeWall® Utility Angle					
Designation	Size	Thick-ness	Lbs./Linear Ft.	Pcs/Skid	Length (ft.)
150L-18*	1.5" x 1.5"	18mil (25ga)	.195	500	10
150L-30	1.5" x 1.5"	30mil (20ga)	.324	500	10
150L-43	1.5" x 1.5"	43mil (18ga)	.468	500	10
150L-54	1.5" x 1.5"	54mil (16ga)	.588	500	10
200L-18*	2" x 2"	18mil (25ga)	.260	500	10
200L-30	2" x 2"	30mil (20ga)	.432	500	10
200L-43	2" x 2"	43mil (18ga)	.624	400	10
200L-54	2" x 2"	54mil (16ga)	.783	400	10
300L-18*	3" x 3"	18mil (25ga)	.391	500	10
300L-30	3" x 3"	30mil (20ga)	.649	400	10
300L-43	3" x 3"	43mil (18ga)	.937	250	10
300L-54	3" x 3"	54mil (16ga)	1.176	250	10

PRODUCT NOMENCLATURE

PrimeWall® Angle is designated as angle width followed by thickness (mils).

Example: 2" angle, 43mil thickness

Designate: **200L-43**

* Knurled legs available in 18mil (25ga) thickness.

PRODUCT APPLICATION

BridgeBar® replaces cold-rolled channel (CRC) for wall bridging. Unique grooves every 4" trap stud web to allow installers to space any type of wall layout. The grooves adjust to various stud thickness to trap the stud web for maximum strength. BridgeBar® incorporates stiffeners to resist compressive loads through the plane of the wall. BridgeBar's standard U-channel shape ensures use through 3/4" and 1 1/2" stud punchouts.

PrimeWall® Cold-Rolled Channel is used to provide support for studs thereby preventing torsional rotation in interior partition walls. PrimeWall® Cold-Rolled Channel is manufactured only from mill-certified steel, providing additional option to other methods of bridging such as BridgeBar® for those who prefer a choice. Cold-Rolled Channel should be attached at each stud with a clip such as BridgeClip® or PrimeWall® Angle.

BridgeClip®, secures BB 150 or 1 1/2" cold-rolled channel (CRC) to stud, resisting both lateral and twisting loads. Tabs on the bottom of a BridgeClip® clamp on the BridgeBar® or CRC, while #10 screws attach the clips to a channel and/or stud through pre-drilled guide holes. Efficient installation is not the only benefit, as BridgeClip® is engineered to accommodate loads that have traditionally been addressed with generic L2x2x16ga.

MATERIAL COMPOSITION

Each BridgeBar® is manufactured from mill certified steel with the following material qualities:

ASTM A653/A653M, Grade 50 (340), 50ksi (340MPa) minimum yield strength, 65ksi (450MPa) minimum tensile strength, G90 (Z275) hot-dipped galvanized coating for BB150; G60 (Z180) hot-dipped galvanized coating for BB75. Material thickness = 33mil (20ga, 0.0346" design thickness-BB150); = 28mil (22ga, 0.0295" design thickness-BB75).

Each BridgeClip® is manufactured from mill certified steel with the following material qualities:

ASTM A653/A653M, Grade 50 (340), 50ksi (340MPa) minimum yield strength, 65ksi (450MPa) minimum tensile strength, G90 (Z275) hot-dipped galvanized coating.

PrimeWall® Cold-Rolled Channel is manufactured from mill certified steel with the following material qualities:

ASTM A1003/A 1003M Non Structural Grade 33 (230), 33 ksi (230 MPa) minimum yield strength, G40 (Z120) hot-dipped galvanized coating, or equivalent.

BRIDGECLIP VALUE

- ◆ Fast installation
- ◆ No clamping
- ◆ No welding
- ◆ Guide holes provided for quick and accurate fastener placement
- ◆ Rounded edges for safety
- ◆ Laborers work on installation, not angle cutting

QUANTITY / ORDER INFORMATION

Bridging Clips				
Designation	Pieces / Bucket	Pieces / Skid	Lbs / Bucket	Lbs / Skid
BridgeClip	250	12000	30	1440
BC600	150	7200	30	1440
BC800	100	4800	28	1344
BridgeBar® Bridging Channel				
Designation	Qty/Box	Lbs/Box	Pcs/Skid	Lbs/Skid
BB75	50	49	2000	1960
BB150	50	70	1250	1750

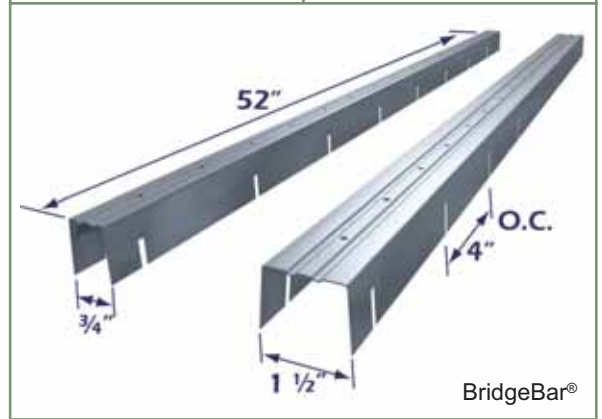
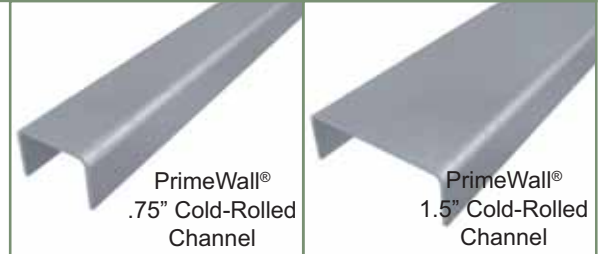
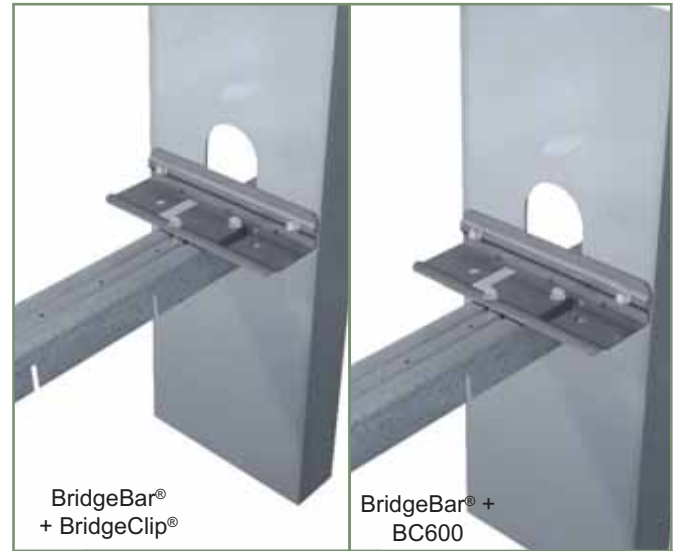

BRIDGEBAR VALUE

- ◆ Fast installation
- ◆ Notches every 4" accommodate 8", 12", 16", & 24" centers
- ◆ No clamping
- ◆ No welding
- ◆ Fifty two" length allows for 4" overlap at joints for continuous walls
- ◆ Guide holes for placement when BridgeClip® is used

PrimeWall® Cold-Rolled Channel

Designation	Size	Thick-ness	Lbs./ Linear Ft.	Pcs/Skid	Length (ft.)
075U50-54	.5" x .75"	54mil (16ga)	.343	500	10', 16', 20'
150U50-54	.5" x 1.5"	54mil (16ga)	.489	500	10', 16', 20'

MIDWALL™ APPLICATION

MidWall™ is The Steel Network's latest in a long line of enhancements to the metal framing industry, providing a tested alternative in partial wall assemblies.

MidWall™ is designed to support out-of-plane loading in cantilevered partial wall systems that are unsupported at the top track. The out-of-plane loads are transferred to the floor system through a ½" thick plate nested in the flanges of the member with two 3/8" diameter fasteners used for the connection. Available in two lengths, 24" and 48", MidWall™ may be used in place of standard framing members, or in conjunction with them to frame the wall.

MIDWALL™ MATERIAL COMPOSITION

MidWall™: ASTM A1003/A1003M, ASTM A653/A653M, Grade 50 (340), 50ksi (340MPa) minimum yield strength, 65ksi (450MPa) minimum tensile strength, G-60 (Z180) hot-dipped galvanized coating. Material Thickness = 118mil (10 gauge, 0.124" design thickness).

MidWall™ Plate: ASTM A36/A36M 08, 36ksi (250MPa) minimum yield strength, 58-80ksi (400-550MPa) tensile strength, ½" thick.

MIDWALL™ NOMENCLATURE

MidWall™ is currently available in two lengths (24" and 48") and three depths (2.5", 3.625", & 6"). Product nomenclature lists the member depth first followed by the height in inches.

For 24" MidWall™ with a 3 5/8" stud, designate 362MW-24.

For 48" MidWall™ with a 6" stud, designate 600MW-48.

MIDWALL™ VALUE

- Replaces labor/coordination of placing embedded angle into floor system
- Provides guide holes for attachment of MidWall™ to the stud (more efficient attachments compared with tube steel)
- Reduces the number of anchors used (2 in MidWall™ vs. 4 in other methods)
- Creates flexibility as two sizes of MidWall™ are available (24" & 48") to enable adjustable wall heights
- Meets current code requirements for handrails and partial walls

24" MIDWALL™ INSTALLATION PROCEDURE

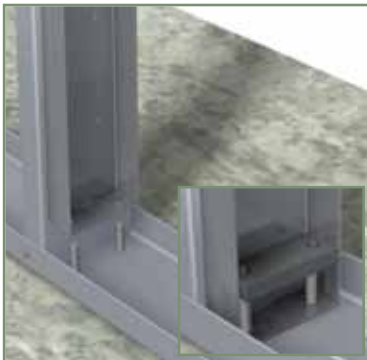

Place MidWall™ 24" against stud web. Insert base plate.



Install nuts/washers on anchors.



Attach MidWall™ 24" to the stud web with #12 screw fasteners through guide holes (fill all holes in the vertical MidWall™ leg).

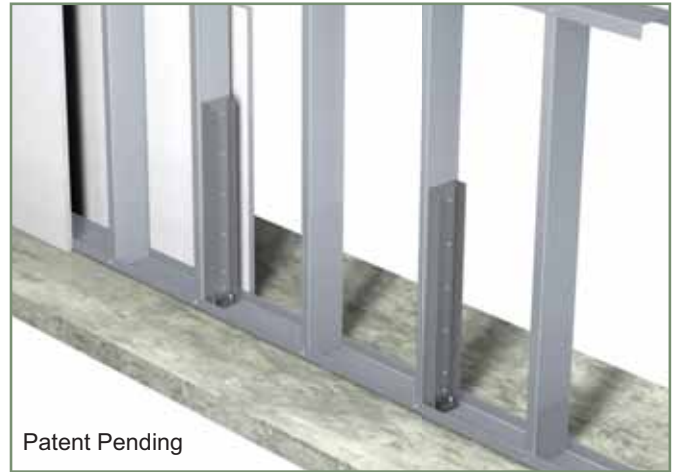

Patent Pending

MIDWALL™ QUANTITY/ORDER INFORMATION

MidWall™ is available by the piece or in pallet (skid) quantities through your local dealer. Each MidWall™ product will be shipped with a separate base plate.

Designation	Pcs/Box	Lbs/Pc	Pcs/Skid	Lbs/Skid
250MW-24	1	6	200	1200
250MW-48	1	8	200	1600
362MW-24	1	8	200	1600
362MW-48	1	11	200	2200
600MW-24	1	10	200	2000
600MW-48	1	14	200	2800

MIDWALL™ DIMENSIONS

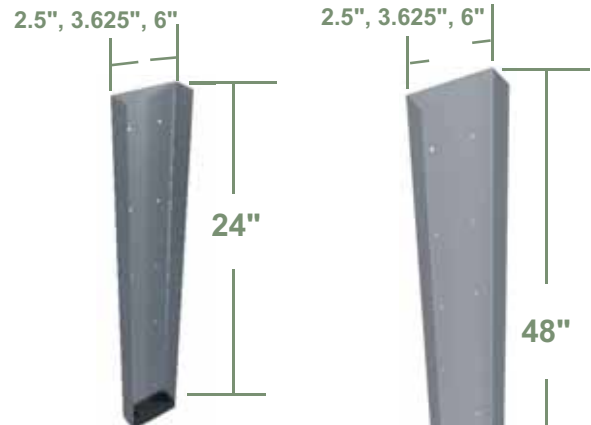

Patent Pending

MIDWALL™ 24" ASSEMBLY EXAMPLE



MidWall™ 24" is generally used in interior half walls of less than 48" in height. Attach MidWall 24" to stud with #12 screws through all pre-drilled guide holes. Maximum spacing between MidWall™ connectors is 36" o.c. (see table below). Contact TSN Technical Services at (888) 474-4876 for design recommendations.

MIDWALL™ 48" ASSEMBLY EXAMPLE



MidWall™ 48" is used in interior half walls equal to 48" in height. Use one MidWall 48" as a substitute for a stud at the specified spacing. Maximum spacing between MidWall™ connectors is 36" o.c. (see table below). Contact TSN for technical support regarding use in exterior or 6" wide walls.

MIDWALL™ DESIGN INFORMATION

CRITERIA

IBC 2003 & 2006

Refer to Section 1607.7.1

Worst case of A or B:

A: 50 lb/ft applied in any direction at the top of wall

B: 200 lbs applied in any direction at any point at the top of the wall

PROCEDURE

A point load at a MidWall™ support is distributed to an adjacent MidWall™ support based on top track stiffness. Refer to the diagram at right for an example of the distribution of the point load, P to adjacent MidWall™ supports.

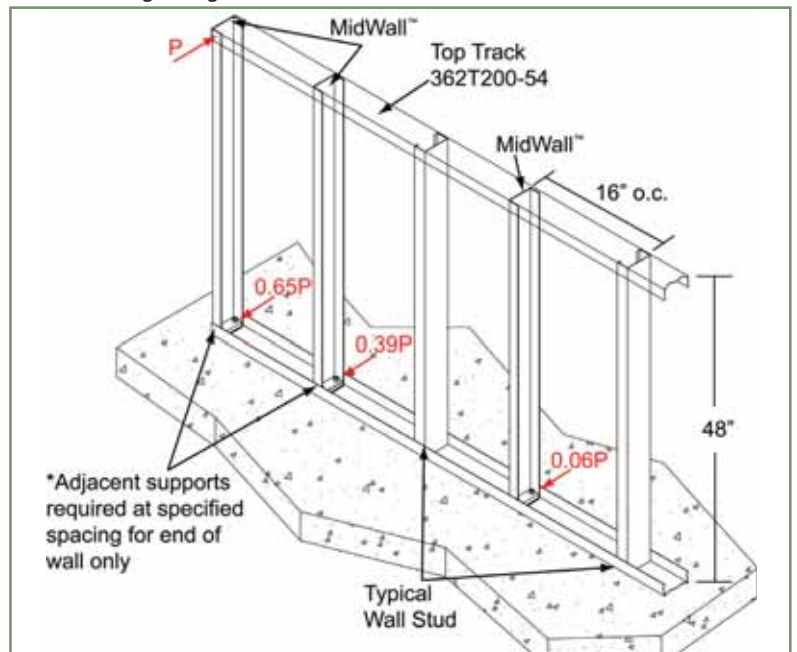

MidWall™ Spacing ¹	Min. Top Track	Max. Tension in Anchor ² (lbs.)	Anchorage Options ² (4,000 psi minimum concrete strength)
24" o.c. (End of Wall requires two MidWall spaced 12")	362T150-54	2685	3/8" HAS Super with HY-150 Max Adhesive, 3-1/2" Embed. (Hilti) 3/8" ASTM A93 GR. B7 Threaded Rod w/ A7 Adhesive, 3-3/8" Embed. (Red Head) 3/8" IXP Anchor w/ Set-XP Epoxy, 3-3/8" Embed. (Simpson)
30" o.c. (End of Wall requires two MidWall spaced 16")	362T200-54	2890	3/8" HAS Super with HY-150 Max Adhesive, 3-3/8" Embed. (Hilti) 3/8" IXP Anchor w/ Set-XP Epoxy, 3-3/8" Embed. (Simpson)
32" o.c. (End of Wall requires two MidWall spaced 16")	362T200-54	2976	3/8" HAS Super with HY-150 Max Adhesive, 3-3/8" Embed. (Hilti)
36" o.c. (End of Wall requires two MidWall spaced 16")	362T200-54	3166	3/8" HAS Super with HVA Capsule Adhesive, 5-1/4" Embed. (Hilti)

¹ At the end of the wall, MidWall is required at given spacing. Typical spacing begins after two adjacent end supports.

² All design data and anchorage options based on 48" maximum wall height.



SteelSmart® System 6

The industry's #1 tool for the design of Members...Connections... Fasteners...Details

Component Design Modules:

- ◆ Curtain Wall
- ◆ Load Bearing Wall
- ◆ X-Brace Shear Wall
- ◆ Floor Framing
- ◆ Roof Framing
- ◆ Roof Trusses
- ◆ Moment Resisting Short Wall



Order online at www.steelSMARTsystem.com

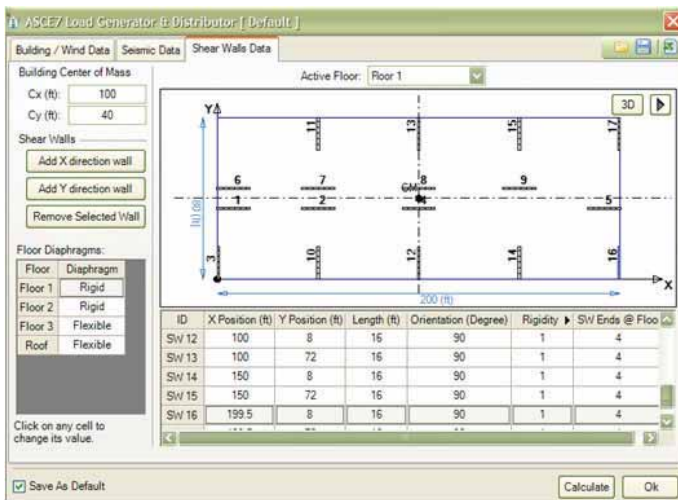

Load Generator and Distributor

The Lateral Load Generator/Distributor tool uses the dimensions and load specification for a building and calculates the total lateral wind and seismic loads according to ASCE 7 Standard "Minimum Design Loads for Buildings and Other Structures". Then, the tool distributes the lateral loads between floors and between shear walls in each floor. The distribution method takes into consideration type of floor diaphragm (rigid or flexible) and torsional effects of rigid diaphragms. The tool exports load data to SW design module and full output to a standard Excel sheet.

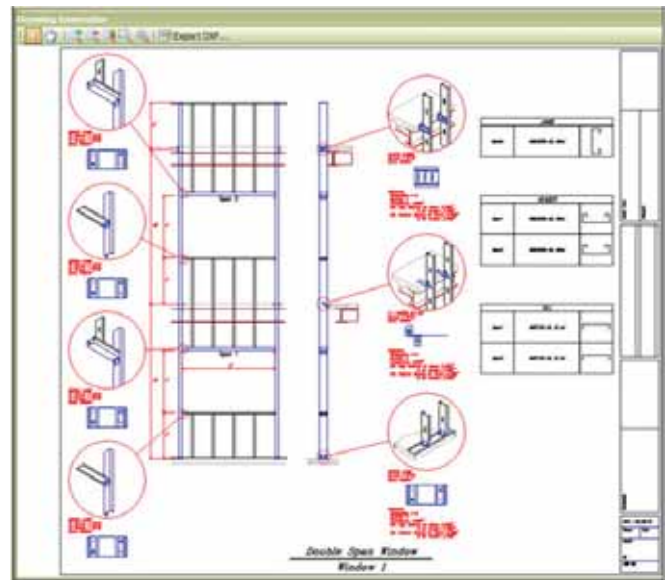

Layout & Details Drawing Generator

A major addition to SSS 6 is the new Layout and Connection Details Generator that plots framing layout of the wall and adds the connection design data (clip designation, # of fasteners, embedment, and screw pattern) to the typical connection detail. The drawing also includes framing members' cross-sections and shapes. The drawing can be exported in AutoCAD® DXF format.



Contact ASI for licensing information:
 Phone: (919) 645-4090
 Fax: (919) 645-4085
 Web site: www.appliedscienceint.com
 Email: asi@appliedscienceint.com



PRODUCT USE

Products in this catalog are designed and manufactured for the specific purposes shown, and should not be used in other applications unless approved by a qualified design professional. All modifications to products or changes in installation procedures should be made by a qualified design professional. The performance of such modified products or altered installation procedures is the sole responsibility of the design professional or installation contractor. The installation contractor and/or qualified design professional are responsible for installing all products in accordance with relevant specifications and building codes.

Customers modifying products or installation procedures, or designing non-standard products for fabrication by The Steel Network, Inc. ("TSN") shall, regardless of specific instructions to the user, indemnify, defend, and hold TSN harmless for any and all claimed loss or damage occasioned in whole or in part by non-standard or modified products or installation procedures.

Loads in this catalog are for the described specific applications of properly installed products. Modifications to TSN products, improper loading or installation procedures, or deviations from recommended applications will affect TSN products' load-carrying capacities. TSN products are fabricated from hot-dipped galvanized steel for corrosion protection but will corrode and lose load-carrying capacity if exposed to salt air, corrosive fire-retardant chemicals, fertilizers, pressure treated wood or other substances that may adversely affect steel or its galvanized coating. This document edition reflects changes in the allowable loads and configurations of some of TSN's products. This information supercedes information in earlier documents or technical reports. All earlier documents or technical reports should be discarded and reference made exclusively to this June 2011 edition. TSN may correct any clerical or typographical errors. All sales are subject to TSN's standard terms and conditions of sale.

LIMITED WARRANTY

TSN warrants its products to be free from defects in material or workmanship at the time of shipment. TSN standard catalog products are warranted for adequacy of design when used in accordance with design limits in this document and properly specified and installed. This warranty excludes uses not in compliance with specific applications and installation procedures set forth in this document. Warranty claims must be made by Purchaser in writing within ninety (90) days of receipt of the Products.

All warranty obligations of TSN shall be limited, at the sole discretion of TSN, to repair or replace the defective product(s). These remedies shall constitute TSN's sole obligation and sole remedy of purchaser under this warranty. In no event will TSN be responsible for incidental, consequential, indirect, exemplary, incidental, special, consequential, or punitive damages, or other losses or damages however caused, including, but not limited to, installation costs, lost revenue or lost profits. TSN's liability for damages shall in no event exceed the applicable portion of the purchase price for defective product(s).

Product defects that arise from acts of God, accidents, misuse, misapplication, improper installation, storage damage, negligence, or modification to product(s) or its components are specifically excluded from this warranty. Product defects that arise from Purchaser providing incorrect information to TSN, including but not limited to incorrect specifications such as incorrect dimensions, designs and/or loads, are also specifically excluded from this warranty. TSN does not authorize any person or party to assume or create for it any other obligation or liability in connection with Products except as set forth herein.

This Warranty is expressly in lieu of all other warranties, expressed or implied, including any warranties of merchantability or fitness for a particular purpose, all such other warranties being hereby expressly excluded.

PATENTED TECHNOLOGY

VertiClip®, VertiTrack®, BridgeClip®, BridgeBar®, BuckleBridge®, StiffClip®, DriftClip®, DriftTrak®, DriftCorner®, JamStud®, StiffWall®, SigmaStud®, CircleTrak®, PrimeWall®, MidWall® and BackIt® are trademarked products, and are patented or patent-pending technologies of TSN. Patent numbers are: #5,904,023; #5,467,566; #5,906,080; #6,701,689; and #6,892,504. Numerous TSN design configurations are patented and/or patent pending and are protected under US and International patent laws.

RETURN POLICY

TSN accepts returns on its standard catalog products under most circumstances. Customers must have TSN authorization prior to any returns. All products must be in original boxes and have full count of pieces; opened boxes or containers cannot be returned. Modified or custom-made products, including all products that have to be specifically cut, assembled, or otherwise produced for specific projects or applications, and specifically including all stud, column, and StiffWall SW-S products, may not be returned for any reason other than warranty claims authorized in advance by TSN. Customer must pay return freight to TSN. No products may be returned after 90 days from delivery. A 20% restocking and repackaging fee will be charged.

CONTACT INFORMATION**RALEIGH LOCATION**

The Steel Network, Inc.
2012 T W Alexander Drive
PO Box 13887
Durham, NC 27709
Phone: (919) 845-1025
Fax: (888) 474-4877

LAS VEGAS LOCATION

The Steel Network, Inc.
6625 Arroyo Springs Street
Suite 140
Las Vegas, NV 89113
Phone: (702) 643-4330
Fax: (702) 643-4331

Web Site: www.steelnetwork.com

E-mail: tsn@steelnetwork.com

Toll Free Nationwide Phone
(888) 474-4876

Copyright © 2011 The Steel Network Inc. All rights reserved. No part of this publication may be reproduced in whole or in part by any method without the prior written consent of The Steel Network, Inc.

"Change is the law of life. And those who look only to the past or present are certain to miss the future." John F. Kennedy

SigmaStud®

The Future of Mid-Rise Construction

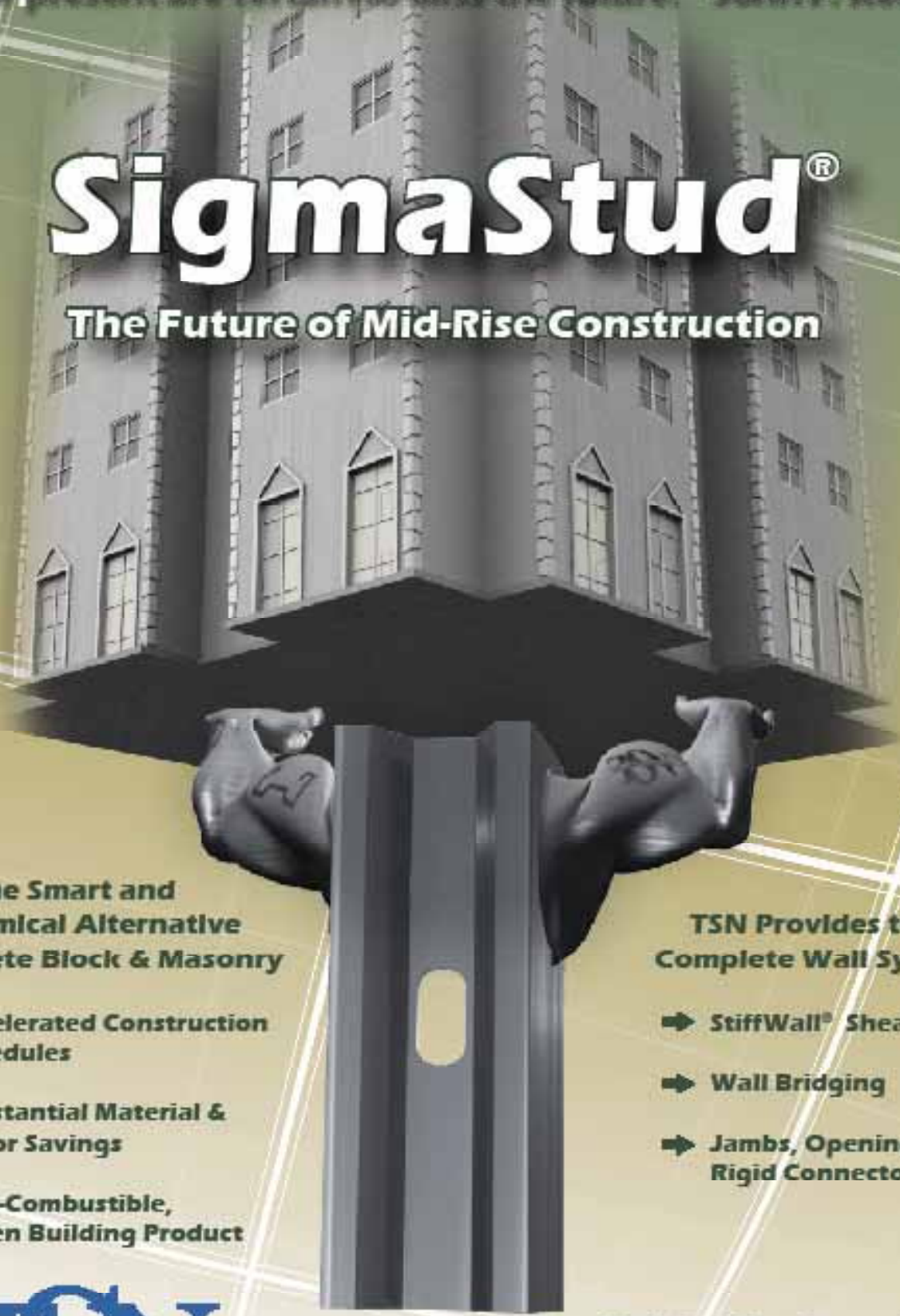

The Smart and Economical Alternative to Concrete Block & Masonry

- ➔ **Accelerated Construction Schedules**
- ➔ **Substantial Material & Labor Savings**
- ➔ **Non-Combustible, Green Building Product**

TSN Provides the Complete Wall System

- ➔ **StiffWall® Shear Wall**
- ➔ **Wall Bridging**
- ➔ **Jams, Openings, & Rigid Connectors**



Available Nationwide!
www.steelnetwork.com
Sales Support: (888) 474-4876