

VertiTrack® VTD

Interior Head of Wall

Material Composition

Clip Material: ASTM A1003/A1003M Structural Grade 50 (340) Type H, ST50H (ST340H): 50ksi (340MPa) minimum yield strength, 65ksi (450MPa) minimum tensile strength, 33mil minimum thickness (20 gauge, 0.0346" design thickness) with ASTM A653/A653M G60 (Z180) hot dipped galvanized coating.

Track Material: ASTM A1003/A1003M Structural Grade 33 (230) Type H, ST33H (ST230H): 33ksi (230MPa) minimum yield strength, 45ksi (310MPa) minimum tensile strength, 33mil minimum thickness (20 gauge, 0.0346" design thickness) with ASTM A653/A653M G60 (Z180) hot dipped galvanized coating.

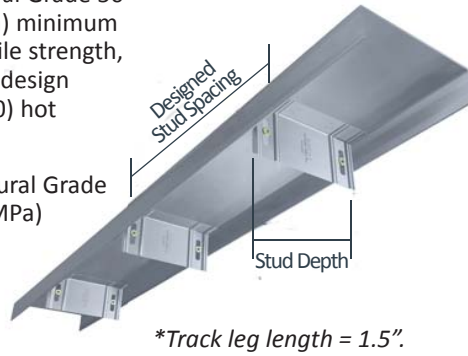

US Patents #5,467,566 & #5,906,080

The attachment of VertiTrack to the primary structure may be made with PAFs, screw/bolt anchors or weld and is dependent upon the base material (steel or concrete) and the design configuration.

VertiTrack VTD Allowable (Unfactored) Loads¹

VertiTrack® VTD, Recommended Allowable Load (lbs): F2 (VertiClip® SLD Loads)					
Stud		VTD250	VTD362/400	VTD600	VTD800
Thickness Mils (ga)	Yield Strength (ksi)	w/2 #8 screws	w/2 #8 screws	w/2 #8 screws	w/2 #8 screws
18 (25)	33	132	132	132	132
27 (22)	33	159	243	243	243
33 (20)	33	159	328	328	328
33 (20)	50	159	359	405	474
43 (18)	33	159	359	405	489
43 (18)	50	159	359	405	664
54 (16)	33	159	359	405	664
54 (16)	50	159	359	405	664
Maximum Allowable Clip Load		159	359	405	682

Load Direction



Notes:

- VertiTrack VTD loads are the same as VertiClip SLD.
- VertiTrack VTD is assembled with VertiClip SLD pre-attached at 16" o.c. and 24" o.c.
- Total vertical deflection of up to 1½" (¾" up and ¾" down). Deflection requirements greater than ¾" (up and down) are available. Custom spacing is also available.
- Fasten within ¾" from the angle heel (centerline of the 1½" leg) to minimize eccentric load transfer.
- Fasten through each VertiClip SLD to structure.
- VertiTrack VTD series is designed to support horizontal loads, and should not be used in axial-load-bearing walls.
- Allowable loads have not been increased for wind, seismic, or other factors.
- #8 screws are provided with each step bushing for attachment to the stud web.
- Strengthening ribs are present in 3 5/8" and 6" sizes.

¹ For LRFD Design Strengths refer to ICC-ESR-1903.

Nomenclature

VertiTrack VTD is manufactured in 12 ft. lengths. VertiTrack is designated by type (VTD), followed by stud depth in inches multiplied by 100 and stud spacing.

Example: 6" deep stud, 16" on center

Designate: VertiTrack® VTD600-16



UL®-Classified Head of Wall Assemblies

HW-D-0003, HW-D-0024, HW-D-0025, HW-D-0036, HW-D-0042, HW-D-0043, HW-D-0044, HW-D-0045, HW-D-0046, HW-D-0047, HW-D-0048, HW-D-0049, HW-D-0054, HW-D-0062, HW-D-0063, HW-D-0066, HW-D-0067, HW-D-0068, HW-D-0069, HW-D-0071, HW-D-0072, HW-D-0073, HW-D-0076, HW-D-0077, HW-D-0082, HW-D-0083, HW-D-0084, HW-D-0085, HW-D-0087, HW-D-0089, HW-D-0091, HW-D-0102, HW-D-0106, HW-D-0152, HW-D-0154, HW-D-0160, HW-D-0162, HW-D-0167, HW-D-0184, HW-D-0185, HW-D-0186, HW-D-0190, HW-D-0193, HW-D-0209, HW-D-0218, HW-D-0246, HW-D-0256, HW-D-0259, HW-D-0263, HW-D-0271, HW-D-0272, HW-D-0275, HW-D-0277, HW-D-0278, HW-D-0280, HW-D-0293, HW-D-0299, HW-D-0310, HW-D-0313, HW-D-0321, HW-D-0322, HW-D-0324, HW-D-0341, HW-D-0342, HW-D-0353, HW-D-0356, HW-D-0357, HW-D-0358, HW-D-0363, HW-D-0365, HW-D-0368, HW-D-0370, HW-D-0371, HW-D-0401, HW-D-0404, HW-D-0420, HW-D-0421, HW-D-0453, HW-D-0455, HW-D-0460, HW-D-0461, HW-D-0462, HW-D-0463, HW-D-0466, HW-D-0468, HW-D-0470, HW-D-0475, HW-D-0477, HW-D-0483, HW-D-0491, HW-D-0526, HW-D-0527, HW-D-0532, HW-D-0545, HW-D-0639, HW-D-0642, HW-D-0644, HW-D-0645, HW-D-0646, HW-D-0687, HW-D-0689, HW-D-0695, HW-D-0696



VertiClip SLD600
ICC-ESR-1903
www.icc-es.org



Meets criteria for New York MEA 326-06-M

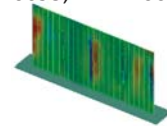

VertiClip SLD Series
Blast and Seismic Design data
www.steelnetwork.com

** For more information or to review a copy of each of these reports, please visit our website at <http://www.steelnetwork.com/Site/TechnicalData>