

DriftTrak® Headed Stud

Slab Integrated Bypass

The Steel Network, Inc. 
 www.steelnetwork.com
 1-888-474-4876

Description

DriftTrak® Headed Stud saves the time and expense of installing DriftTrak after the concrete slab has been poured, by integrating it directly into the slab before pouring. The headed studs come preinstalled to the DriftTrak and function as the attachment to the post-tensioned slab instead of welding to the pour stop angle or use of PAF's or anchors. Once concrete is poured, the DriftTrak is ready to support exterior steel framing using any DriftTrak Bypass clip (DTSLB-HD or DTLB-HD) to accommodate vertical deflection and lateral drift requirements or provide a rigid attachment to the floor slab.

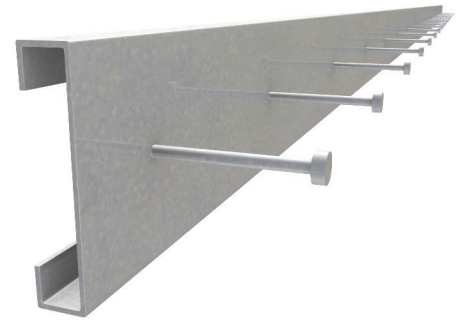

US Patent #7,503,150 & Patent Pending

Material Composition

Track Material: ASTM A1003/A1003M Structural Grade 50 (340) Type H, ST50H (ST340H): 50ksi (340MPa) minimum yield strength, 65ksi (450MPa) minimum tensile strength, 97mil minimum thickness (12 gauge, 0.1017" design thickness) with ASTM A653/A653M G60 (Z180) hot dipped galvanized coating.

Headed Stud Material: ASTM A29/A108, Grades 1010 through 1020 or equivalent, 45ksi (310MPa) minimum yield strength, 55ksi (380MPa) minimum tensile strength, 3/8" diam. x 3 1/8" length with 3/4" head diameter.

Clip Material: *DriftTrak – Headed Stud can be used with DTSLB-HD and DTLB-HD clips:* ASTM A1003/A1003M Structural Grade 50 (340) Type H, ST50H (ST340H): 50ksi (340MPa) minimum yield strength, 65ksi (450MPa) minimum tensile strength, 97mil minimum thickness (12 gauge, 0.1017" design thickness) with ASTM A653/A653M G90 (Z275) hot dipped galvanized coating.

DriftTrak Headed Stud Allowable Loads

DriftTrak® Headed Studs with DTSLB600-HD & DTSLB800-HD, Recommended Allowable Load (lbs): F2 DriftTrak® Headed Studs with DTLB600-HD & DTLB800-HD, Recommended Allowable Load (lbs): F2 & F3									
Stud		F2 Allowable Loads				F3 Allowable Loads			
		DTSLB600-HD & DTSLB800-HD		DTLB600-HD & DTLB800-HD		DTLB600-HD Offset = 1" max		DTLB800-HD Offset = 2" max	
Thickness Mils (ga)	Yield Strength (ksi)	w/2 #12 Screws	w/3 #12 Screws	w/4 #12 Screws	w/6 #12 Screws	w/4 #12 Screws	w/6 #12 Screws	w/4 #12 Screws	w/6 #12 Screws
33 (20)	33	377	565	754	1,130	258	309	226	264
33 (20)	50	544	817	1,089	1,525	373	446	327	381
43 (18)	33	561	841	1,122	1,525	384	460	336	393
43 (18)	50	810	1,215	1,525	1,525	555	664	486	567
54 (16)	33	789	1,183	1,525	1,525	540	647	473	552
54 (16)	50	1,139	1,525	1,525	1,525	780	934	683	797
68 (14)	50	1,525	1,525	1,525	1,525	1,103	1,321	996	1,127
97 (12)	50	1,525	1,525	1,525	1,525	1,163	1,392	1,019	1,189
Max Allowable Clip Load		1,525		1,525		1,903		1,272	

Notes:

- Recommended ASD steel strength per headed stud in tension or shear = 1,600 lbs.
- Designers must check headed stud tension and shear anchorage capacity in concrete per ACI 318 based on actual headed stud edge distance and concrete compressive strength. For more information, call TSN Technical Support at 1-888-474-4TSN.
- Allowable load tables incorporate eccentric loading of fasteners.
- Loads listed reflect force in a single direction. When multiple loads react on the connection, it is the responsibility of the designer to check the interaction of forces.
- Torsional effects are considered on screw group for F3 allowable loads. It is assumed that all of the torsional moment is taken by the connection to the stud.
- Design loads are for attachment of DriftTrak to stud only. Load tables reflect horizontal loads (F2) and vertical loads (F3)
- Allowable loads have not been increased for wind, seismic, or other factors.
- Clips are manufactured to fit into the DriftTrak and provide a rigid/slip connection to the stud, and free lateral movement of the structure.
- One row of bridging is recommended at a maximum distance of 18" from DriftTrak if no other stud lateral restraint is present.

Load Direction

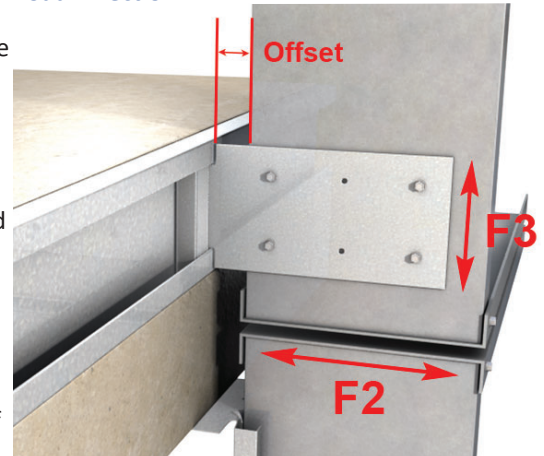

Nomenclature

DriftTrak® Headed Stud comes in 10' or 12' lengths, with headed studs in a single, centered row (See drawing on next page). To specify DriftTrak, list "DTH," followed by the length.

Example: 12 ft. length

Designate: DriftTrak® DTH – 12ft.

DriftTrak® Headed Stud: Dimensions, Layout and Stud Spacing

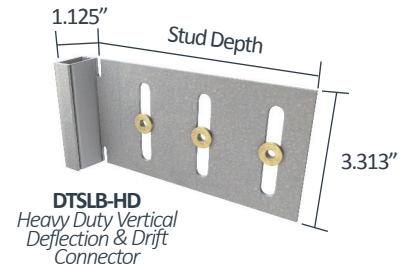
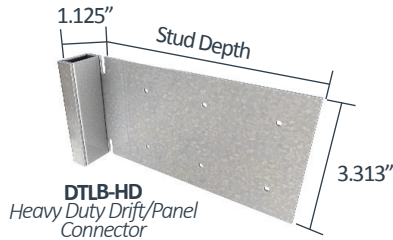
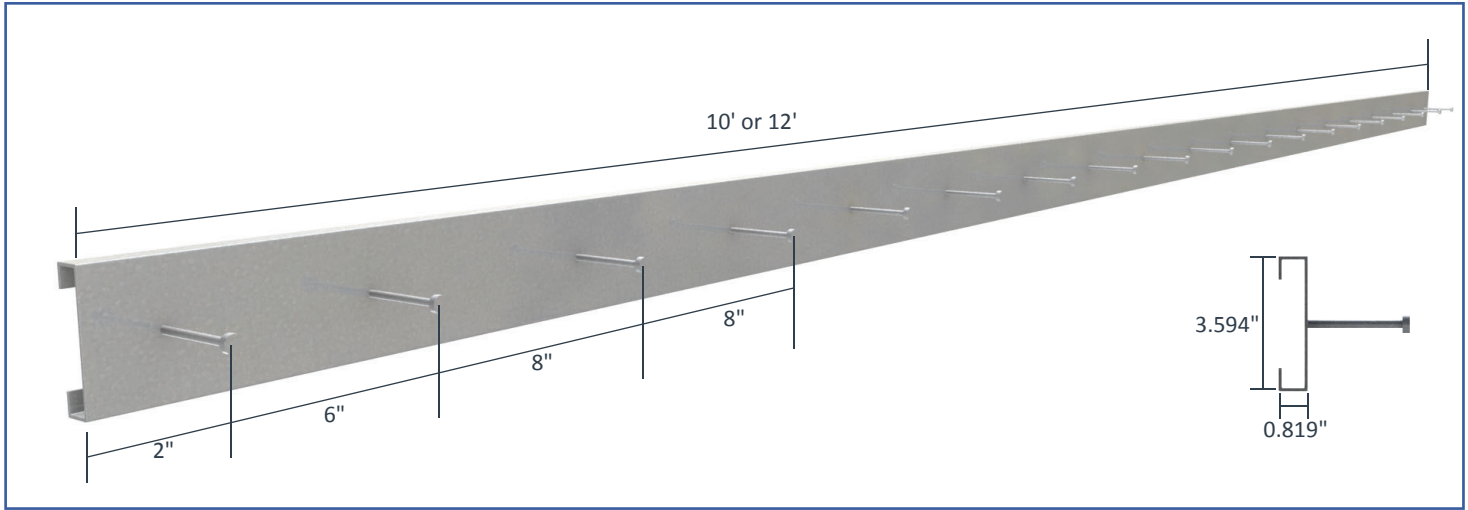

Fastener Patterns

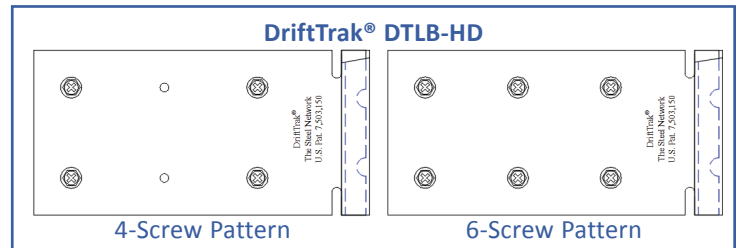
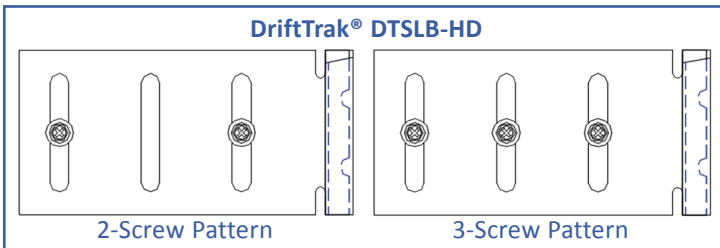

Example Details

